

# Mapping the Links between Water, Poverty and Food Security

Report on the Water Indicators workshop  
held at the Centre for Ecology and  
Hydrology, Wallingford, UK, 16 to 19 May,  
2005

No  
1

Report authors: Caroline Sullivan<sup>1</sup>, Charles J. Vörösmarty, Eric Craswell, Stuart Bunn, Sarah Cline, Claudia Heidecke, Adam Storeygard, Alex Proussevitch, Ellen Douglas, Deborah Bossio, Dirk Günther, Anna Maria Giacomello, Dermot O'Regan, and Jeremy Meigh (dec.)

<sup>1</sup> See Appendix 1 for full contact details.

Report Date: August 2006

Please Cite As: Sullivan et al., 2006. Mapping the Links between Water, Poverty and Food Security. Report on the Water Indicators workshop held at the Centre for Ecology and Hydrology, Wallingford, UK, 16 to 19 May, 2005. GWSP Issues in GWS Research, No.1. GWSP IPO, Bonn. Available at: [www.gwsp.org](http://www.gwsp.org).

# IMPRINT

## Publisher:

The Global Water System Project  
International Project Office  
Walter-Flex-Str. 3  
D-53113 Bonn  
Germany

The Global Water System Project (GWSP) is a joint project of the Earth System Science Partnership (ESSP) consisting of four Global Environmental Change Programmes: the International Geosphere-Biosphere Programme (IGBP), the International Human Dimensions Programme (IHDP), the World Climate Research Programme (WCRP), and DIVERSITAS, an international programme of biodiversity science. The *overarching question* of the GWSP concerns how human actions are changing the global water system and what are the environmental and socio-economic feedbacks arising from the anthropogenic changes in the global water system.

*Issues in Global Water System Research* is a report series designed to review and record scientific knowledge about the global water system, and to stimulate discussion amongst researchers, practitioners and decision makers in this field. The papers undergo reviews arranged by the Global Water System Project, but do not present final research results and should be considered as works in progress.

## Contact:

GWSP IPO  
Phone: + 49 228 73 6188  
Fax: + 49 228 7360834  
Email: [gwsp.ipo@uni-bonn.de](mailto:gwsp.ipo@uni-bonn.de)  
<http://www.gwsp.org>

**Editors:** Marcel Endejan, Daniel Petry, Lara Wever, Robin Leslie (linguistic editing)

**Design:** Karina Waedt, Grafik & Design, Bonn, Germany

**Layout:** Katharina Moraht

**Printers:** medienHaus Plump GmbH, Rheinbreitbach, Germany

## Dedication

*Jeremy Meigh 1954-2006*

*This Issue is dedicated to the memory of Jeremy Meigh who died in February 2006. Without Jeremy's original contribution to the work on water resources assessment and to the development of the Water Poverty Index, the workshop and this publication would not have transpired.*



# TABLE OF CONTENTS

Executive summary.....	7
Acknowledgements.....	8
1 Introduction.....	9
2 Meeting objectives.....	10
3 Meeting process.....	11
4 Workshop activities.....	11
4.1 The modelling group: testing and using the Global-RIMS.....	11
4.2 The conceptualization group: detailed analysis of the content and structure of the WPI.....	12
5 Findings from the workshop discussion groups.....	13
5.1 Modelling group: testing the Global-RIMS system.....	13
5.2 Conceptualization group: potential to use or develop the WPI structure for use in CPWF basins.....	14
5.3 Examining the potential to capture environmental issues through indicators.....	15
5.4 Examining the potential to capture water productivity issues through indicators.....	19
5.5 Conclusions from the discussion of the conceptualization group.....	20
6 Workshop outputs.....	22
6.1 Global-RIMS outputs from the workshop modelling activities.....	22
6.2 Outcomes from the indicator conceptualization process.....	25
6.3 Construction of a fast-track basin indicator for use in the CPWF basins.....	25
6.4 The structure of the WWI.....	27

6.5	An illustration of the WWI in the Mekong Basin.....	28
6.6	A longer term alternative: the Water Vulnerability Matrix.....	34
7	The way forward.....	36
7.1	Immediate.....	36
7.2	Medium to longer term.....	36
8	Conclusions.....	39
	References.....	40
	Appendixes.....	42
Appendix 1.	List of Participants.....	42
Appendix 2.	Agenda.....	43
Appendix 3.	Overview of the Global Rapid Integrated Monitoring System (Global-RIMS).....	46
Appendix 4.	Global-RIMS indicator development table.....	50
Appendix 5.	Sample Map Images: Application of Global-RIMS to Selected River Basins.....	52
Appendix 6.	Comment on Variables Used to Calculate a Preliminary WWI for the Mekong Basin.....	54
Appendix 7.	A suggested structure for a Water Vulnerability Matrix.....	58

## EXECUTIVE SUMMARY

The use of indicators is perceived to have increasing importance in the water sector. This report outlines progress in the refinement of integrated approaches to indicator development addressed during a one-week workshop held in May 2005 at the Centre for Ecology and Hydrology (CEH) in Wallingford, UK. This was attended by representatives from a number of institutions with an interest in water indicators and particularly by those with an interest in their international and basin application. The workshop was initiated by the Global Water System Project (part of the Earth System Science Partnership), which has an interest in using indicators in its forthcoming Digital Water Atlas. In addition, the Challenge Programme for Water and Food is currently seeking solutions on how indicators can best be used in comparative river basin studies; it was considered useful to streamline the efforts of these two groups on indicator use. Having extensively reviewed the indicator literature, these two programmes have expressed interest in the structure of the Water Poverty Index (WPI), an holistic and integrated water index developed from research led by the CEH. As a result, it was decided to combine these initiatives at this workshop, with a view to generating an indicator more specifically targeted towards the linked issues of water, poverty and food security, as well as the need for basin-scale assessment.

During the meeting, considerable discussion took place on the structure and use of integrated indices such as the WPI. Strengths and weaknesses of such indices were identified, and suggestions were made on how these could be addressed at the basin scale. With a focus on food and health in relation to water and poverty, a new set of indicator variables was identified after several periods of intense discussion in breakout groups. Discussion also focused on the structure of such indices, and the use of a more complex matrix structure was considered. It was agreed that the output of the indicator component of this workshop will remain as an index; in order to differentiate it from the WPI, it will be referred to as the "Water Wealth Index" (WWI) because the term "poverty" is often considered to be pejorative.

The workshop also provided an excellent opportunity to facilitate the testing of the Global-RIMS web-based integrated monitoring tool. This has been developed by the University of New Hampshire and consolidates some 130 global data sets. The tool facilitates the calculation of integrated queries, and generates values that can be used in a variety of ways. The facility for mapping the outputs provides users with useful visualization tools; the meeting provided a pilot testing ground for its application in a variety of major river basins throughout the world.

While there is much further work to be done on both of these tools, much progress has been made in addressing the challenges associated with data assimilation, data integration, up and down scaling, data representation and indicator structures. It is hoped

that the initiative described in this report will be regarded as progress in this debate, and will serve to highlight priority areas for future work. It is important, however, that the contents of this report are viewed as the preliminary result of work in progress, and with more time, these results will become much more complete and robust.

## ACKNOWLEDGEMENTS

**T**he water indicator workshop was supported and funded by the UK Centre for Ecology and Hydrology (International Fund for Agricultural Development Project), the Global Water System Project, the CGIAR Challenge Programme for Water and Food, the International Water Management Institute (IWMI), and the Water Systems Analysis Group of the University of New Hampshire. Other support was provided by CIESIN at Columbia University, NASA (grant NAG5-11750), the universities of Bonn and Osnabrück, and by Griffith University, Australia.

We also acknowledge the US National Aeronautics and Space Administration (NASA) for support resulting in the development of the Global-RIMS (grant NAG5-11750; Project Office: Land Surface Hydrology, Program Manager Dr Jared Entin). The software package and data sets were backstopped by the United Nations Educational, Scientific, and Cultural Organization (UNESCO) and by the United Nations Environment Programme (UNEP).

Funding for this publication was provided by the German Federal Ministry of Education and Research (BMBF) and the government of North Rhine-Westphalia.

Editorial assistance was provided by Robin Leslie.



## 1. INTRODUCTION

**W**ater management challenges and the pressure to implement Integrated Water Resources Management (IWRM) have given rise to continued interest in the development of integrated approaches to water resources assessment and water indicators. Coupled with the pressure generated by the agreement on the Millennium Development Goals (MDGs), the issue of indicators has become more urgent. They are being addressed by two international initiatives – the Global Water System Project (GWSP) and the Challenge Programme for Water and Food (CPWF) of the Consultative Group on International Agricultural Research (CGIAR). This report discusses the indicator workshop, which was convened to facilitate discussion on how these programmes can contribute to this debate.

The GWSP (GWSP, 2005) is described as science driven but policy informing, and it has three core objectives:

- To quantify changes in the global water system, and the sources of these changes
- To reveal feedback in the earth system (integrated modelling)
- To assess system adaptation and resilience (policy implications)

If the work of the GWSP is to be of real use to policy-makers and water managers at various levels, it is important that it works towards integration of physical and social science data, and for this reason the GWSP has evinced interest in the work of the Water Poverty Index (WPI) which already addresses this issue within its structural framework (Sullivan 2002; Sullivan et al. 2003).

The CPWF has the overall objective of stabilizing global diversions of water to agriculture at year 2000 levels, while increasing food production. This can be summarized as

- Producing more food with less water
- Changing the way water for food is used
- Changing water and food research methods

As a global programme, the CPWF has identified nine major river basins across the world, selected to represent the variety of problems facing large basins, particularly in the developing world: the Sao Francisco Basin, the Andean Basin system, the Limpopo Basin, the Nile Basin, the Volta Basin, the Indo-Gangetic Basin, the Yellow River Basin, the Mekong Basin, and the Karkheh Basin.

It will be important for the CPWF to monitor basin conditions, not only to improve understanding of the strengths and weaknesses of the project, but also to evaluate the impact of CPWF projects. In particular, the CPWF will probably extend over 15 years so it will be important to ensure delivery of useful outputs and real progress towards improvements in food and water productivity over this duration. The establishment of a common and accepted frame of reference for this evaluation is therefore an essential prerequisite to generation of successful basin outcomes.

Furthermore, indicators are highly significant as tools to communicate with decision-makers and the public, as well as for presenting CPWF results to donor agencies. However it must be noted that, ideally, indicators are useful for comparisons both within and between basins, but there is significant variation in data availability depending on the basin, and any area selected within it. In terms of CPWF objectives, key indicators of progress would be associated with diversion of water for food production, malnourishment and poverty. While many of these factors are captured within the structure of the WPI, there is potential for it to be more targeted towards food security and water productivity.

Participants at the meeting came from different institutions, which in addition to the UK Centre for Ecology and Hydrology, the GWSP, the CPWF and IWMI, included CIESIN, the universities of New Hampshire (United States), Osnabrück (Germany), and Griffith University (Australia). A full list of participants can be found in Appendix 1.

## 2. MEETING OBJECTIVES

This meeting evolved from discussions held during the GWSP conference in Bonn in February 2005. At that time it was agreed that a group of researchers working on indicators should come together to initiate meaningful dialogue on ways to link the indicator efforts of the GWSP and the CPWF. It was agreed at that juncture to meet at the Centre for Ecology and Hydrology (CEH) in Wallingford, and that participants should bring data and models to be analysed during the time spent together. Professor Charles Vörösmarty suggested that one activity could be to try to combine the modelling efforts of the Water Systems Analysis Group of the University of New Hampshire, with the analytical structure provided by the WPI, developed from work led by the CEH.

As a result of this combined effort, it was anticipated that a number of outputs would be of use to both of these programmes, and to other researchers and end users. These would include:

- Integrated data maps, which may be relevant to the GWSP Digital water atlas, and
- An integrated index which can possibly be used as a baseline indicator for the Challenge Programme basins

More generally, it was felt that progress could be made within the group on issues related to data harmonization, model debugging, data sharing, and scale.

### 3. MEETING PROCESS

The meeting was designed to provide an opportunity for intensive discussion. The first day involved presentations and discussions within the core team, with other members of CEH staff contributing additional information on specific topics of relevance (water quality and climate change). During the second day, technical presentations addressed data sources and modelling approaches. Breakout groups were formed to discuss Index Conceptualization and Data Issues and Utilization of Global-RIMS. In the third phase of the work, the team worked in plenary (hands-on trials of Global-RIMS); consequently appropriate indicators were identified and calculated to support the revised structure of the WPI, based on data from various sources.

During the presentations session, there was a suggestion to consider the use of a matrix structure rather than an index (see Appendix 7). However it was decided that much more work would have to be done to develop an entirely new structure and this was not appropriate at this juncture, but it would most certainly be part of any medium-term plan for further work on this issue.

### 4. WORKSHOP ACTIVITIES

At various intervals during the workshop, two groups were formed, one to discuss conceptualization of an index appropriate for the CPWF (the conceptualization group), and the other to consider the Global-RIMS tool itself and the issue of data integration (the modelling group).

#### 4.1 The modelling group: testing and using the Global-RIMS

As a contribution to the development of the GWSP, the University of New Hampshire has been working on a global water analysis tool called the Global Rapid Integrated Monitoring System (Global-RIMS). This tool displays and manipulates gridded data sets via a web interface; it has been developed to the prototype stage and tested during the workshop by the participants. As the Global-RIMS software is based on a web server, it can be accessed and used by multiple users at the same time via a web browser such as FireFox, Netscape, etc. This facilitated the testing process, achieving a number of goals. These included:

- Demonstration to the workshop participants of the value of the system
- Generation of integrated information about the Challenge Programme basins
- Calculation of selected variables which can be used as parameters of the integrated indicator being developed in the workshop
- Testing and debugging of the system by non-specialist users

## 4.2 The conceptualization group: detailed analysis of the content and structure of the WPI

The WPI (Sullivan 2001, 2002) is a water management tool, first conceived to address water investment prioritization and the type of monitoring required for evaluation of water-related MDGs. It was developed through extensive consultation; different indicator approaches were tested during the DFID<sup>2</sup>-funded project to develop and test a water poverty index. Extensive data collection and testing were carried out in urban and rural conditions in three countries. Consequently, a composite index structure was selected, and the methodology was applied at community (Sullivan et al. 2003) and national scales (Sullivan et al. 2002). There has been further work to examine the scale issues associated with integrated indicators such as the WPI (Sullivan et al. 2006), and the methodology has also been applied to address the problem of climate change impacts on water resources (Sullivan and Meigh 2005). WPI implementation prerequisites were examined by Sullivan and Meigh (2003) and the methodology has been evaluated and reviewed by a number of policy-makers and water professionals in developing countries (Sullivan et al. 2002). The structure of the WPI is shown in Box 1.

**Box 1.** *The structure of the WPI*

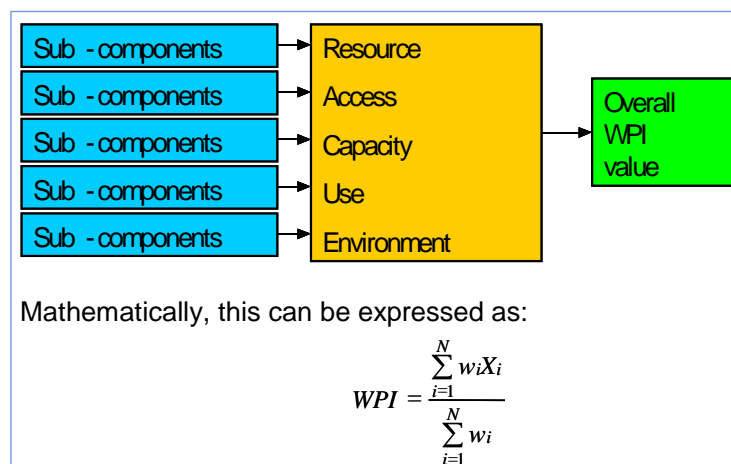

The importance of a tool such as the WPI has been highlighted as being a useful tool within the suite of methods that are needed for sustainable water management (Wallace et al. 2003). In this workshop, it was decided to review the structure of the WPI, and attempt to generate an integrated indicator which was more focused on the issue of food security and agricultural water use, in order to be of more relevance to the Challenge Programme. It was decided to attempt to apply this revised methodology to one of the four CPWF focal basins (Mekong, Volta, Kharkeh, Sao Francisco). The Mekong Basin was selected for this purpose, as this allowed use of both large-scale global data sets

<sup>2</sup> DFID: The UK Department for International Development

(such as the Global-RIMS data sets), and spatially distributed provincial data from local sources, which have been accumulated by the Mekong River Commission. This represents an important synergy between widely available global Earth system science and more specialized regional-scale databases, the combination of which is required for robust formulation of indicators and indices (Vörösmarty 2002).

## 5. FINDINGS FROM THE WORKSHOP DISCUSSION GROUPS

**T**his section elaborates on discussions and activities carried out in the two discussion sub-groups. The results from the discussion groups are provided in Section 6.

### 5.1 Modelling group: testing the Global-RIMS system

The IT system used in this study, Global-RIMS, represents a consolidation of prior research leading to geospatial indicators of water system state and stress at continental and global scales (see Vörösmarty et al. 2000, 2005a,b). Testing and modification of the Global-RIMS software were carried out by the modelling group and the issue of data integration from differing data sets was addressed. Following this refinement process, all of the participants were able to test the tool. Subsequently a number of novel data combinations and indicators were generated, some of which are to be used in the calculation of certain parameters of the Water Wealth Index (WWI). In addition, the process contributed to the development of:

- Spatial integration of parameters (data sets)
- Exploratory expressions of selected combinations of parameters, applied both at the scale of whole river basins, and for component sub-basins, floodplain areas etc.
- Statistical analysis of calculated data
- The capacity to re-sample data sets with mismatching resolution (either upscaling or downscaling). This is very useful when calculations have to be performed over a set of data sets with different resolution
- The option to generate calculated results as files in common GIS data exchange format (ArcInfo GridAscii format) to be re-used for other GIS software
- Logarithmic transformations for data visualization that are critical for high variability data sets and calculations
- A range of colour schemes for selection by a user to display calculation results

After the workshop, it was anticipated that the Global-RIMS software system along with available data sets will be mounted on a web server at the University of New Hampshire to be used for further studies by the GWSP group.

## 5.2 Conceptualization group: potential to use or develop the WPI structure for use in CPWF basins

### General discussion

- What are the basins' characteristics?
- What do they need from their indicators to present their situation?
- What data do we need and what are available?
- How can we assemble other data sets?
- How is it possible to introduce water productivity and crop productivity into the WPI?
- Potential for application of the WPI at a basin scale (can be used as a framework for analysis for the CPWF basins)

### Discussion on specific WPI components and key points on variable issues

There was lengthy discussion on what components and variables could be appropriate for application in CPWF basins. Key issues of what is needed to capture the WPI (and other) components are outlined in Box 2.

### General points arising from the discussion

A number of general points included issues relating to the redundancy of indicators – perhaps some could be linked to ease data collection; autocorrelation and linkages between components need to be checked. There is also a need to address sensitivity of variables and models, and examine if indicators can provide a boundary condition on a model in this context. It was pointed out that variables and indicators need to be diagnostic and interlinkages should be made explicit. Models can capture links and then show how circumstances can change; it was mooted whether the state and linkages to the state need to be characterized.

From the outset, the need for indicators and support should be considered. It is also necessary to decide on standardized variables on agreed scales, to facilitate comparisons both within and between basins. Monitoring of trends and other water-related activities (e.g. pollution) at a basin scale is required, but concomitantly how data needs for sub-basin scales may be addressed must be considered. Scale of interest in any analysis should be defined, and with vulnerability data, there may be different threats for each basin, so appropriate indicators may be needed for different locations or scales.

As the WPI has substantial overlap with CPWF aims, it could be tested for the Mekong, using data from the Mekong River Commission and the Global-RIMS. In fact, a variation of this was achieved during the workshop, where data from the Mekong were used to generate a preliminary integrated indicator (WWI, hereunder) for the Mekong.

### 5.3 Examining the potential to capture environmental issues through indicators

A major challenge for society is to satisfy the growing demands for food and water, without degrading natural ecosystems and the services they provide. River systems are regarded as the most threatened ecosystems on the planet (Malmqvist and Rundle 2002); we recognize that, to meet this challenge, we need to include measures of environmental assets (goods/services) as part of an overall assessment of “water wealth”. However, we acknowledge that few data sets of direct measurements of aquatic ecosystem health are available to make global comparisons among basins or countries. In light of this, our aim is to identify robust and defensible surrogates of aquatic ecosystem health that can be modelled at the global scale. Given the data issues, these are more likely to be based on drivers of ecosystem health than direct measures of it.

#### 5.3.1 Global indicators of aquatic ecosystem health for rivers

The meeting discussed and proposed four major groups of indicators of aquatic ecosystem health to be considered in global comparisons of river basins. These included three major drivers of river ecosystem health: flow regime and water quality change, barriers to dispersal and land use. If possible, we would also like to include some direct measures of biodiversity.

#### 5.3.2 Flow regime change

There is no doubt that the modification of natural flow regimes has a major impact on aquatic biodiversity and river ecosystem health (Bunn and Arthington 2002). In previous global river assessments, this is often included as a simple measure of change in mean discharge ( $Q$ ). However, this does not reflect ecologically important components of the flow regime and is likely to be misleading. For example, it is possible to deliver a percentage of the mean discharge as a fixed environmental flow allocation in many ways. However, significant ecological impacts can result because of, *inter alia*, shifts in the timing, seasonality and predictability of important flow attributes (Postel and Richter 2003). In highly variable river systems, a small percentage of the mean  $Q$  may in fact be a large proportion of the flow in many years, leading to significant impacts on river ecosystems. If allocations of water for extraction are fixed (e.g. as is often the case for licensed entitlements) irrespective of interannual variability, environmental allocations may not be available in many years. It is clear that we need measures of flow regime alteration that are ecologically relevant. These are likely to include attributes of variability, seasonality and spell duration and will need to take into account the likely differences among climatic regions.

**Table 1.** *Potential parameters for use in the construction of a comprehensive and integrated water management index*

<b>Resources</b>	<ul style="list-style-type: none"> <li>• Indicators of water supply</li> <li>• Mean on its own is not enough</li> <li>• Need to capture variability</li> </ul>
<b>Access</b>	<ul style="list-style-type: none"> <li>• Need indicators of capacity for infrastructure</li> <li>• Need to include institutions/legal framework (difficulty with data availability)</li> <li>• Can we capture consequences of decisions?</li> </ul>
<b>Poverty</b>	<ul style="list-style-type: none"> <li>• Any index needs to capture heterogeneity</li> <li>• Need to identify what is invested in water</li> <li>• What are the most appropriate scales for this type of indicator, especially from an operational perspective?</li> </ul>
<b>Food security</b>	<ul style="list-style-type: none"> <li>• Food security involves food availability, food access, food utilization, vulnerability</li> <li>• Need to identify the most important variables to capture food security</li> <li>• How are these linked to other indicators – need to avoid double counting</li> </ul>
<b>Water quality</b>	<ul style="list-style-type: none"> <li>• Investigate seasonality in water quality indicators</li> <li>• Need to consider both anthropocentric sources and in-stream processes</li> <li>• Can possibly derive estimates from land use, or data integration rather than chemical assessment</li> <li>• Could the assessment of pollution concentrations and dilution factors satisfy water quality issues in indicators?</li> </ul>
<b>Environment</b>	<ul style="list-style-type: none"> <li>• Simple indicators are inadequate</li> <li>• Any environment indicator must include variability and error</li> <li>• Could use land use as a surrogate for environmental health in rivers</li> <li>• Ongoing work on environmental flows assessment methods from the collaborative</li> <li>• Global Rivers Sustainability Project (led by Colorado State University) may generate some better indicators for this component in the future (see Section 7.2)</li> </ul>
<b>Capacity</b>	<ul style="list-style-type: none"> <li>• How to capture capacity without too many indicators</li> <li>• Must include infrastructural capacity to store and control water</li> <li>• Should include legal and institutional issues, including enforcement</li> </ul> <p><b>Note:</b> It was agreed that this could be the most important issue to be included under</p>



	<p>capacity, but this was almost impossible at present (especially for global coverage), due to lack of data</p>
<b>Climate</b>	<ul style="list-style-type: none"> <li>● High uncertainty in climate data – even rainfall data can be uncertain, but still needs to be included, especially from regional climate models (instead of GCMs)</li> <li>● Extreme events and impacts could be useful indicators for CPWF basins</li> <li>● Could link to IPCC</li> <li>● Need to look at probability and consequences of climate change in basins</li> <li>● Need to resolve the scale issue – climate models are at a much larger scale than hydrological models or socio-economic information, but within-grid downscaling for some variables can be straightforward</li> <li>● There is also a temporal scale to be addressed</li> <li>● Linking different types of models requires them to include the same processes (e.g. off-line hydrological models and RCMs)</li> </ul>
<b>Use</b>	<ul style="list-style-type: none"> <li>● Need to build data sets</li> <li>● Agricultural water use – as agriculture is the major water user, it needs more emphasis</li> <li>● How can we deal with rain-fed agriculture as agricultural water-use data only relate to irrigation water and do not include rain-fed agricultural water consumption?</li> <li>● Data issues associated with the way that data are classified by sectoral use</li> <li>● Need to reflect domestic, industrial and agricultural use</li> <li>● Lumping them together masks their real impact, especially with respect to agriculture, the largest user</li> <li>● There should be an attempt to reflect productivity</li> <li>● Improvement in efficiency in the agricultural sector is warranted</li> <li>● Competition for water is usually between agriculture and the environment, while domestic and industrial use, being much smaller, will tend to have less of an impact</li> <li>● Agricultural water use should reflect productivity not efficiency</li> <li>● How can consumptive water use, re-use, fisheries etc. be included?</li> <li>● How can we address rain-fed agricultural water use when all data on agricultural water use relate to irrigation?</li> <li>● Need to explicitly address water use for food production and security</li> <li>● How can we address uncertainty?</li> </ul>

### 5.3.3 Connectivity and fragmentation

The maintenance of hydrological connectivity (both lateral and longitudinal) is known to be an important determinant of several aspects of river health including aquatic biodiversity and fisheries production (Bunn and Arthington 2002). Many riverine species of fish and crustaceans move vast distances throughout the channel network as part of their life history requirements (e.g. anadromous fish such as salmon and palaemonid shrimps). Dams and weirs disrupt longitudinal connectivity and fragment populations, often leading to major declines in biodiversity (Pringle 2001). Migratory species often form the basis of productive commercial, recreational and subsistence fisheries in many river basins and are typically the most affected by barriers.

In many river systems, ecosystem health is dependent on the natural pattern of inundation of floodplains (Junk et al. 1989). Fish production in floodplain rivers is often a function of the area and duration of floodplain inundation during large flow events, as species capitalize on vast food resources. Furthermore, some species depend on these flood events to reproduce or recruit on inundated floodplains. Isolation of floodplains by levees and the conversion of floodplain vegetation to cropland or dense urban land uses greatly reduce lateral connectivity and are considered to be major impacts on river ecosystems (Tockner and Stanford 2002).

Proposed indicators of changes to longitudinal connectivity could include:

- Number of dams or other significant barriers per kilometre of river channel (or per catchment area)
- % river network (km channel) or % catchment isolated upstream of barriers

Proposed indicators of changes to lateral connectivity could include:

- human population density on floodplains
- % floodplain isolation (by levees or roads)
- % intensive land use (urban, cropping) on floodplains

### 5.3.4 Land use/water quality

There are well-documented relationships between the amount of agricultural land use (or urban land use) and water quality (Allan 2004). Similar observations have been made between land use and aquatic biodiversity in streams and rivers. In the absence of direct measurements of water quality, measurements of land-use pressure might be used to infer likely impacts on river health. Potential land-use indicators could include:

- % catchment under cropping or intensive agriculture
- % urban land use or population density
- a direct inventory of geographically varying loadings (e.g. Green et al. 2004)

Data sets may be available at the global scale for estimates of sediment and nutrient loading. It would be useful to obtain measures of salinity (conductivity) and/or the per-

centage of salinized land. The latter would be particularly important in dryland river basins.

### 5.3.5 Biodiversity

It is unlikely that comparable data sets will be available for direct measurement of aquatic biodiversity. However, it may be possible to obtain data on numbers of threatened species in river systems. It may also be possible to obtain fisheries data for major rivers and their estuaries. The latter is known to be directly influenced by flow and sediment regimes (Loneragan and Bunn 1999).

While this section has tried to identify ways in which water requirements for the maintenance of river health and ecological integrity may be captured, there is much work yet to be done in this field. Some thoughts on the way forward in this context are provided in Section 7.

## 5.4 Examining the potential to capture water productivity issues through indicators

To satisfy growing demands for food and water without degrading natural ecosystems and the services they provide in many cases requires improving the productivity of water (increasing societal benefit per unit of water consumed). In the original WPI the “use” term was designed to reflect this by considering the efficiency of water use (%GDP/unit water) in three sectors – domestic, industrial and agricultural. It was noted that in the national level WPI analysis, the “use” term had the least impact on the overall index. This was considered a weakness as wise use of water, especially in agriculture (the largest consumptive user of water), is one area where significant improvement can often occur. As part of the iterative process which is essential in the development of a tool to capture such complexity, this improvement has potential to have direct benefits for the environment. The newly designed WWI should continue to reflect these three areas, but the term “productivity” (to replace “use”) could be weighted by volumes of water consumed in each sector to emphasize the importance of productivity in the sectors that use the most water.

Data limitations for defining and understanding agricultural water productivity are a major constraint. Most agricultural water-use values are based on irrigated agriculture only, while 70 percent of water consumed to produce food is in rain-fed systems. Much discussion is now ongoing within the CPWF, at IWMI and within other institutions, on how best to define and measure water productivity in agriculture. Agricultural water-use statistics report only irrigation water and under-report this statistic in many countries where informal irrigation can be even of greater importance than formal systems. Measures of irrigation efficiency have yet to be harmonized along the full set of pathways from source waters to end use. Recharge of otherwise “lost” water upon extraction

that can be used by downstream users, for example, distorts traditional measures of efficiency and water productivity (Molden 2003). Remote sensing and global data sets have the potential to greatly improve assessments of water productivity over current national and sub-national statistics. This area should be considered more carefully in the medium to long term, as the WWI and global analysis evolve. A decision that must be made is whether the WWI will try to reflect productivity in terms of output (product per unit water), value (US dollars per unit of water), or some other measure of value (jobs per unit of water). Both job and revenue data are available for the Mekong, and can be used for the preliminary analysis. There is also a need in the future to try to capture a better understanding of water needs to support rain-fed agriculture, and how its efficiency may be improved.

### 5.5 Conclusions from the discussion of the conceptualization group

**For immediate application**, a restructured version of the WPI has been constructed; it was decided that this would be referred to in the future as the Water Wealth Index (WWI) (an alternative name could be the Water Vulnerability Index [WVI]). Each name reflects a slightly different meaning, and it is worth bearing this in mind when making a final decision. The structure of such an index would comprise a measure of water resources which constrain the following components:

- Food security
- Health
- Productivity
- Institutional and human capacity
- Environment

Table 2 provides suggested parameters that reflect these issues, and an example of the approach applied to the Mekong Basin is shown in the results provided in Section 6.4.

**In the medium term**, it was decided to work towards a more comprehensive structure, which would overcome some of the difficulties associated with the use of indices. A possible structure for such an approach was suggested under the name Water Vulnerability Matrix (WVM) and a suggested outline of this is given in Appendix 7. More discussion of this potential approach is provided in the results in Section 6.5.

**Table 2.** Selected parameters for use in a Water Wealth Index (WWI)

Food Security	Health	Productivity	Institutional Capacity	Environment
<p><b>Rate of malnourished children</b></p> <p><b>Food deficit</b></p> <p><b>Vulnerability, i.e.</b>                      - Climate (CV flow)                      - Dependence on irrigation (food from irrigated agriculture)                      - Political vulnerability, gini coefficient, mobile phones</p>	<p><b>Access to sanitation</b></p> <p><b>Under 5 years mortality</b></p> <p><b>Access to safe domestic water</b></p>	<p><b>Domestic water use per capita, with cut off</b></p> <p><b>Industrial water use (jobs/km<sup>3</sup> by province)</b></p> <p><b>Agricultural water use (jobs/km<sup>3</sup> by province)</b>                      (could combine revenue generated per km<sup>3</sup> with job data)</p>	<p><b>Participation</b> (water rights, mobile phones)</p> <p><b>Gender</b> (female labour force participation rate)</p> <p><b>Expenditure on investment</b> in the water sector as a proportion of total fixed capital formation (annual, per capita)</p> <p><b>Education</b> (literacy, enrolment rates)</p> <p><b>Infrastructure</b> (proxy by access to electricity)</p> <p><b>Institutional capacity</b></p> <p><b>Effectiveness of water management</b> (leakage or water unaccounted for)</p>	<p><b>Flow change</b> (modified RWSI)</p> <p><b>Fragmentation</b> (population on floodplain)</p> <p><b>Water quality</b> (land use, re-use)</p> <p><b>Agricultural pressure</b> (crowding on cropland)</p> <p><b>Nitrogen loading?</b></p> <p><b>Biodiversity</b> (endangered fish?)</p>

## 6. WORKSHOP OUTPUTS

**W**orkshop outputs are divided into two types: (1) Parameter values created by integration of selected data, and the subsequent production of maps. These are referred to as Global-RIMS outputs and are detailed in Section 6.1. (2) Outputs from the integrated indicator work on the WWI; these are detailed in Sections 6.3 and 6.4.

**NOTE:** These outputs have been generated to illustrate the benefits of the approach. The values indicated here cannot at this stage be taken as definitive, as there is a need to refine and recheck all parameter values before a final version of the data values or maps is generated.

### 6.1 Global-RIMS outputs from the workshop modelling activities

A number of examples are provided to illustrate the value of the Global-RIMS tool. Figure 1 shows how different types of data have been linked using the Global-RIMS software for data from the Mekong Basin; this demonstrates how data queries and calculation of Global-RIMS can be combined with GIS outputs to link biophysical and social data sets.

Figure 1. *Linking and displaying different types of data*

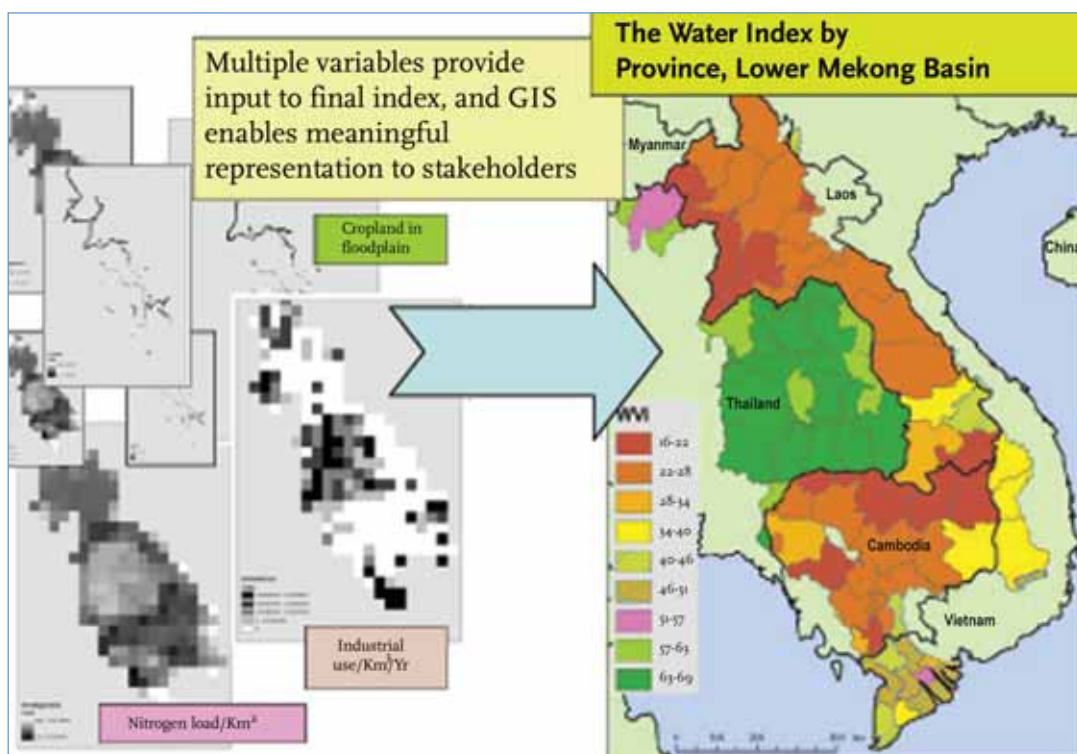

**Figure 2. Investigating problems in the Mekong River**

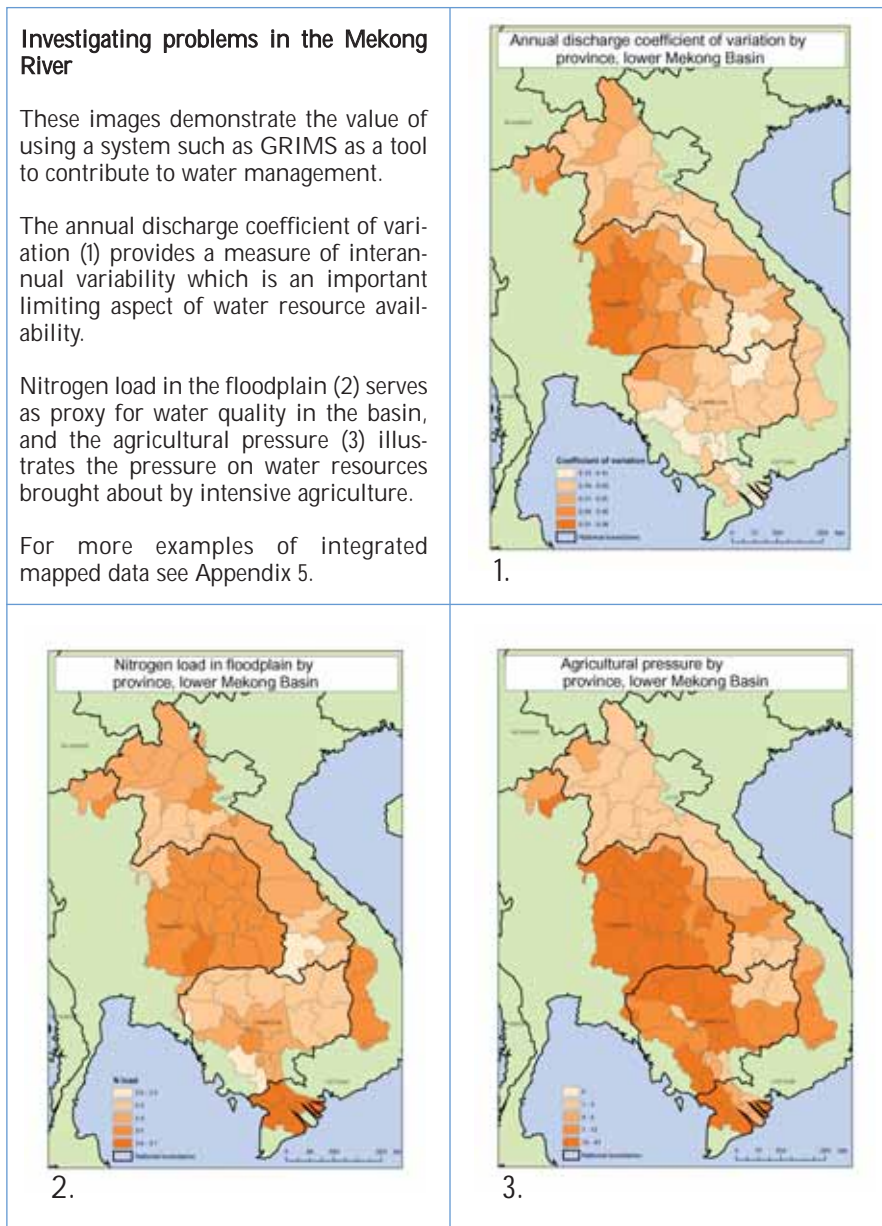

***The Mekong River – illustrating the floodplain***

Plotting elevation in a log scale highlights quite a large area of potential flood zone within the lower tributary of the Mekong River, and northwest of its delta (Figure 2). Administratively it is located right at the geographical centre of Cambodia. This potential flood zone looks like a north-west elongated depression and is connected to the Mekong River by a rather narrow channel. It might indicate a potential location for quite substantial groundwater storage or recharge, from its favourable topographic structure (see Figure 3). This structure indicated potential flood zone resembles a bowl that could easily collect groundwater and it could be easily trapped there by a narrow outflow channel leading out of the depression. This would have to be investigated further by hydro-

geologists to be confirmed, but it is a good example of how this tool can be used to identify certain features of a location.

**Figure 3.** *Potential flood zone and underground water storage*

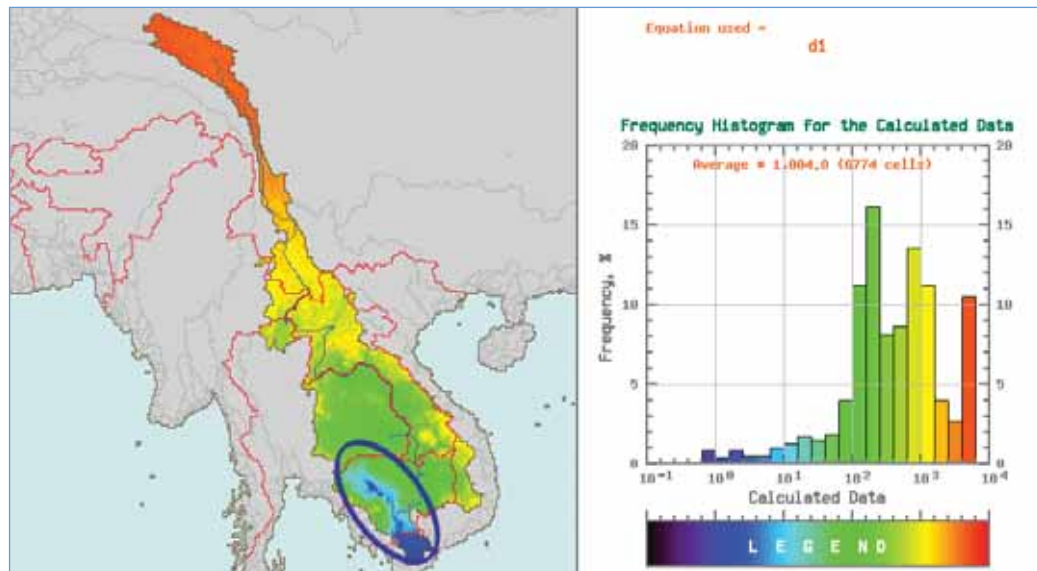

Using log scales can be useful to identify potential water storage areas. In this example, the southwest of the lower part of the Mekong River (highlighted by the blue circle) is visible only in the log scale of the elevation map, which is very sensitive to low gradient changes in landscape. This approach could also be used to examine the impact of sea level rise. Plotting this elevation map of the Mekong Basin in a linear scale cannot pick up this kind of feature, as shown in Figure 4, where the same data used in Figure 3 are expressed in a different way.

**Figure 4.** *Linear scale elevation map of the Mekong Basin*

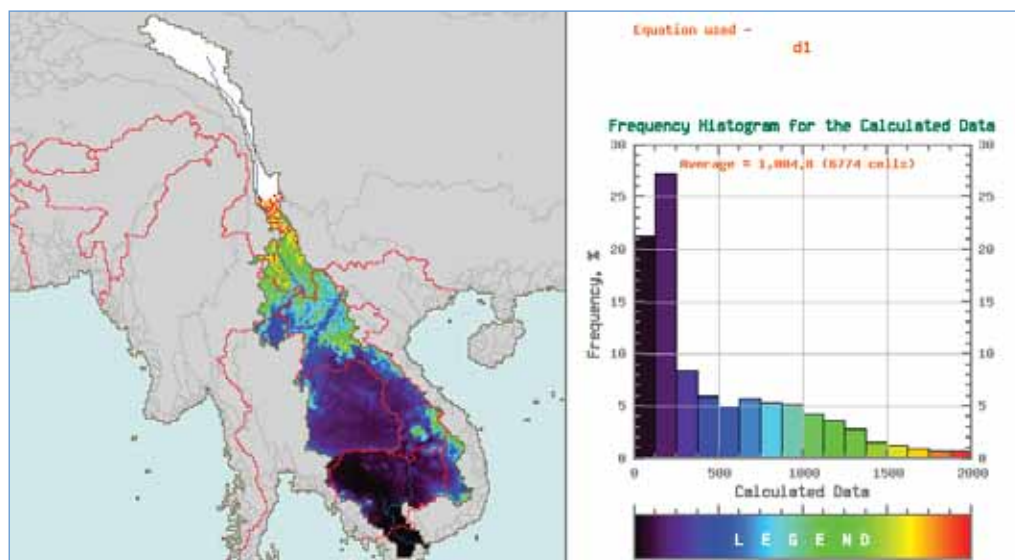



## 6.2 Outcomes from the indicator conceptualization process

The development of a conceptual framework for a common indicator set between the GWSP and the CPWF was one of the objectives of the workshop, but another objective was to develop an indicator set which would be usable directly after the workshop. The difference between these two objectives was discussed in depth during the workshop on several occasions. It was unanimously agreed by those present in the group that work would need to be done to identify, verify and evaluate a number of indicator variables which are not currently in use, mainly to address the need for more effective ways of capturing diverse institutional issues associated with water management. It was also agreed that a fast-track baseline indicator could be developed from a composite indicator model, and this, as far as possible, would make use of existing data in the Challenge Programme basins. The benefit of this approach was that it could begin the process of streamlining a generic approach to basin-scale evaluation, in which data management techniques and analytical methods could be applied meaningfully to all basins, in spite of their wide diversity. The drawback is that by relying on existing data, some important variables cannot readily be assessed. This may be particularly relevant to variables which can better describe the threats, linkages and underlying dynamics of the global water system. There is a clear need for these issues to be addressed, but it is hoped that future work will build on progress achieved so far.

## 6.3 Construction of a fast-track basin indicator for use in the CPWF basins

The work on the development of the WPI led by the CEH has been chosen as a basis on which to build the proposed integrated indicator set. Much has already been published on this work, and the WPI has been applied in several different locations and at different scales. Much discussion was directed towards the various advantages and disadvantages of this approach, but it was unanimously agreed that the WPI work had much to offer as the model for application in the CPWF basins. Specific parameters were identified and included to capture issues such as food security and health which are important to the CPWF, and a new index structure was developed. This concept is illustrated in Figure 5.

The proposed WWI differs from the original structure of the WPI (see Box 1) in a number of ways. In this new structure, the resource component is removed and treated separately as a natural baseline endowment, which acts as a constraint on the other components. In this way, infrastructure in the water sector is treated as part of “capacity”, now renamed “institutional capacity”, to highlight the importance of institutions in water management issues. New components have been added (Food, Health), replacing Access and Use, which is now represented by productivity. The name Water Wealth Index is also considered better as it does away with the term “poverty”, which some

users considered inappropriate, as it is sometimes perceived as being pejorative. This structure was discussed at length, and it was unanimously felt that this could provide a useful framework for the immediate needs of the Challenge Programme. A representation of the conceptualization of the WWI is shown in Figure 5, and its structure is explained. The specific components which have been selected to represent this structure have been identified to capture important issues such as food security and water productivity, both of which are of importance to both the achievement of the MDGs and the Challenge Programme. These specific components are shown in Table 3.

Figure 5. Conceptualization of the WWI

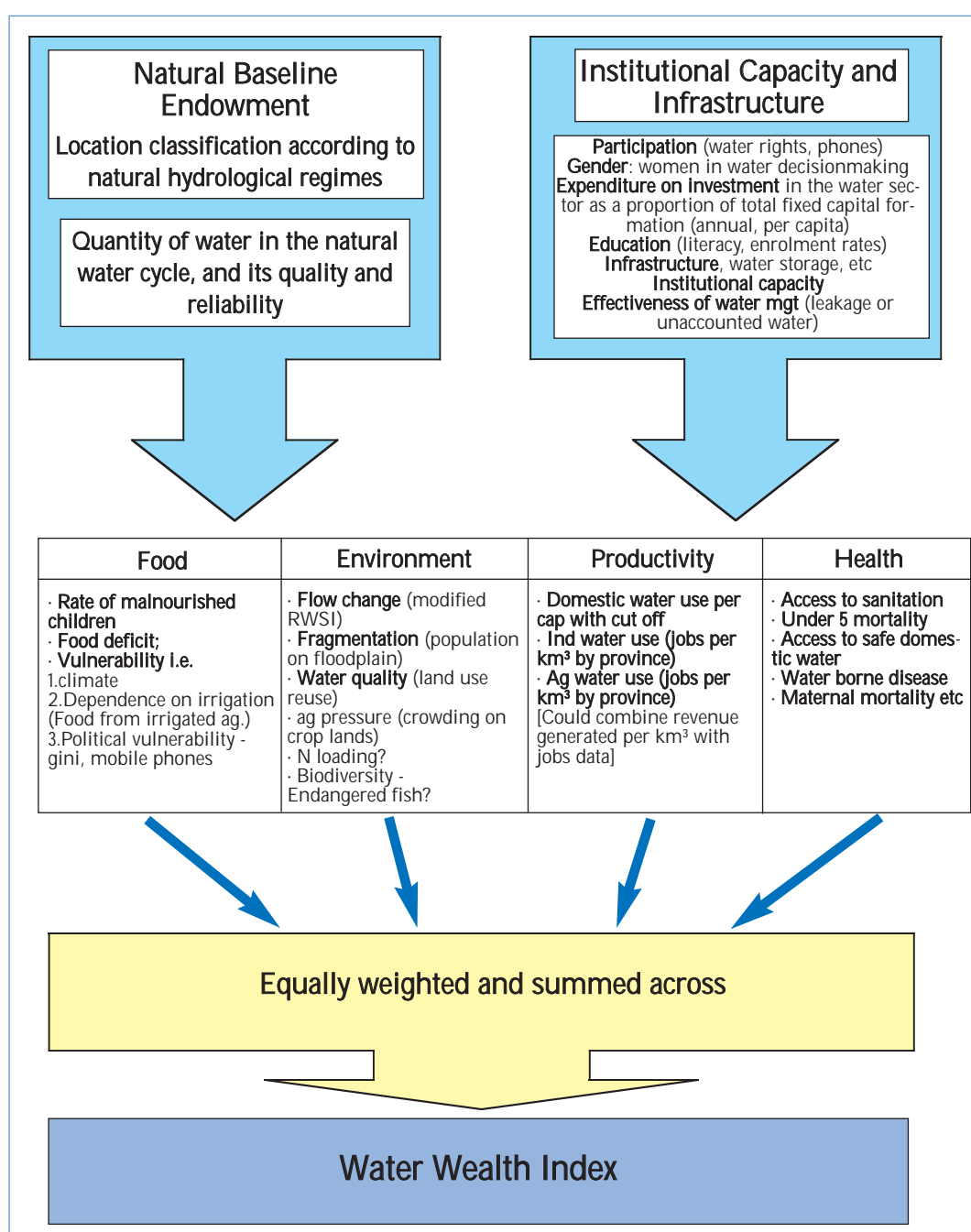

## 6.4 The structure of the WWI

For the purpose of developing the WWI, various elements representing key characteristics of water-related food and environmental security issues are measured on the basis of data from different sources. While these data may be measured in different units, they can be manipulated by first normalizing their values to a range between 0 and 100. A weighting system can then be applied to indicate the relative importance of each of the elements, to indicate their relative importance. Since the determination of the importance of different elements of the WWI may be considered as a political decision, it is felt that there should always be a calculation made with equity-value weightings, to provide a consistent and comparable baseline. For the purpose of this preliminary work, all weights are equally set to a value of one.

As seen in Figure 5, this analysis is based on the idea that both the quantity of water and the way it is managed both act as constraints to the effectiveness of water delivery. As such, they (water and institutions) are shown in the equation below to impact on all other variables. The design of the formula illustrates the theoretical structure of a weighted index with these two components acting as constraints or enhancement on the others:

$$WWI = \frac{w_f F(NBE, I) + w_h H(NBE, I) + w_p P(NBE, I) + w_e E(NBE, I)}{w_f + w_h + w_p + w_e} \quad [1]$$

Where NBE, F, H, P, I and E represent the following:

*NBE* = Natural Baseline Endowment, capturing water resource availability, based on best available hydrometeorological data modified by temporal variability and quality measures. (Note: infrastructure influencing the actual availability at any one location is captured within the capacity element, also acting as a constraint.)

*F* = food availability and vulnerability of supply related to water

*H* = human health issues related to water supply and sanitation

*P* = productivity, based on economic values and employment opportunities related to water availability

*I* = institutional capacity, incorporating managerial and financial resources and their effectiveness in the water sector, including water-related infrastructure

*E* = ecosystem integrity, as measured by disruption of aquatic ecosystems resulting from anthropogenic activity

We believe this is an improvement on other approaches as it reflects quite accurately the reality which we face, i.e. our activities are limited by the water available to us, but could be either limited or improved by the way we manage it.

Equation [1] can be refined as follows:

$$WWI = (NBE + I) * \frac{w_f F + w_h H + w_p P + w_e E}{w_f + w_h + w_p + w_e} \quad [2]$$

Note: Equation 1 illustrates a generic approach, reflecting a “balance model” approach. Equation 2, a sub-set of equation 1, is assuming a linear relationship between the variables NBE and I and the variables F, H, P and E. However, to improve this work, we really would need to better understand the real relationships between the components, specifically how F, H, P and E are related to both NBE and Capacity and Institutions (I).

For the purposes of these calculations, each component has been organized in such a way that higher values indicate better conditions. This means that locations with high values on the WWI do better than those with lower values. To illustrate the ideas in this paper, we have made an attempt to apply this approach to data from the Mekong Basin. Due to the short time available during the workshop, and the exploratory nature of the work, we have had to omit some parameters and use a simpler structure, but the specific variables used to calculate the WWI as illustrated by the examples in this report are listed in Table 3.

### 6.5 An illustration of the WWI in the Mekong Basin

In order to calculate the WWI at the basin scale, suitable parameters first had to be identified, and then appropriate data assembled from a variety of sources. These included data from the University of New Hampshire’s Global-RIMS data set, from the World Bank World Development Indicators data, from CIESIN databases, from the World Resources Institute data set and data from the Mekong Basin Commission (MBC). The Mekong was specifically selected for this example to illustrate the possibility of combining data from the global set with locally generated data. In some cases, provincial level data were used directly from the MBC data set, and in others, GIS techniques were used to distribute basin values by province. This provided a means by which the data from the different sources could be used. In some provinces, averaged data had to be used where no local value was available. While this is by no means perfect, it does serve as a means to demonstrate the principles of combining data from different sources as a way of producing useful information for end users.

The calculation of the WWI scores shown here is made on the basis of the provisional mathematical structure as outlined in Section 6.4. Provisional values of the WWI at the provincial level are shown in Figure 6. The mathematical structure suggested here for the WWI reflects a composite index made up of components relating to food and nutrition, health, efficiency of water use, institutional effectiveness and the environmental

**Table 3. Definitions of specific variables included in the WWI**

Parameter	Content
<b>Health</b>	Health has been operationalized by three parameters with reference to water. The definitions of the single parameter vary slightly from country to country. In this table the definitions describe how the parameter has been understood during the workshop. Possible deviations in the different countries are mentioned as well.
Access to sanitation	Access to adequate sanitation has a greater influence on health than safe water supply. In general, adequate sanitation usually refers to the availability of a latrine in or near the house, or a flush toilet. However, definitions vary between countries. Cambodia uses the percentage of people with flush toilets, latrines and traditional pit latrines, with or without connection to a sewer/septic tank. In Lao PDR the percentage of population with access to a toilet of any kind is used and in Thailand the percentage of households with flush latrines and moulded bucket latrines. Viet Nam gives no further definition of access to sanitation. WHO/UNICEF (2004) have a standard nomenclature which would be useful to adopt.
Access to safe domestic	Access to safe domestic water is the percentage of people having access water to a resource of safe drinking water. The sources included vary from country to country. In Cambodia water that is either piped, tube well, pipewell, or purchased drinking water is captured. In Lao PDR resources from piped water or protected wells are used. In Thailand access to bottled drinking water, tap-water, rainwater or a private well builds the source for the parameter. Viet Nam does not elaborate on safe water.
Child mortality under 5	Child mortality under 5 is defined in general as the number of child deaths before reaching the age of five in relation to 1,000 live births. Because these data were not available for the Mekong River Basin, neither for the countries nor for the regions, data from the parameter "infant mortality" are used. Infant mortality is defined as the number of infants dying before reaching one year of age, per 1,000 live births in a given year.
<b>Environment</b>	
Flow change	Composite index for Flow Deviation Change Relative Water Stress Index, RWSI (sum of domestic, industrial, agricultural water use/available water supply; DIA/Q)
Fragmentation of habitats	Degree of floodplain isolation
Water quality	Nitrogen load in kg/km <sup>2</sup> /yr Sediment load Percentage of saline soils of the total area in km <sup>2</sup>
Biodiversity	The biodiversity of the river basin is defined by the number of threatened species of fish (from DIVERSITAS).

<p><b>Food</b></p> <p>Malnourished children</p> <p>Food self-sufficiency</p> <p>Climate vulnerability</p> <p>Political vulnerability</p>	<p>As for most other indicators, this indicator is defined differently in the four countries in the Mekong River Basin. In general it means the proportion of children under five who are underweight for their age group. Cambodia defines the indicator as the percentage of children more than two standard deviations below the mean weight for a healthy reference population. For Lao PDR and Viet Nam it is defined as the proportion of moderately underweight children under five years. Thailand use the definition “Percentage of children suffering first-degree mal nutrition”.</p> <p>Dependence on irrigation (food from irrigated agriculture).</p> <p>The vulnerability of a river basin to climate variation is an important factor of the potential of the basin to ensure food security. Climate vulnerability is measured as the rate of crop failure per crop area (in km<sup>2</sup>) due to extreme events and impacts.</p> <p>Not measured in the Mekong exercise. Could include a measure of income distribution (gini coefficient) or use of mobile phones as a proxy.</p>
<p><b>Capacity</b></p> <p>Participation</p> <p>Expenditure in the water sector</p> <p>Education</p> <p>Infrastructure</p> <p>Institutional capacity</p>	<p>Not measured in the Mekong exercise. Possible indicators for this category could be a quantification of water rights and the amount of female participation in water management.</p> <p>Total expenditure on the water sector as a proportion of total fixed capital formation (a proxy has had to be used here until better data become available)</p> <p>Education index, (literacy, enrolment rates) from the HDI</p> <p>Proxy by access to electricity</p> <ul style="list-style-type: none"> <li>● Participation (mobile phones/water rights)</li> <li>● Gender: female labour force participation rate</li> <li>● Proxy alternative, scores judged by basin experts: low/med/high</li> <li>● Leakage rates, estimates of the value of water unaccounted for</li> </ul>
<p><b>Water productivity</b></p> <p>For domestic, industrial, agriculture use</p>	<ul style="list-style-type: none"> <li>● Domestic water use per capita with cut off</li> <li>● Industrial water use (jobs/km<sup>3</sup> by province)</li> <li>● Agricultural water use (jobs/km<sup>3</sup> by province)</li> </ul>

impact of water use. In this structure, water resources and institutional capacity are both quantified and considered as a constraint to the other four components (Food, Health, Productivity, Environment). In this way, the measure provides a holistic assessment of the effectiveness of water resources use, and an indication of the strengths and weaknesses of the sub-components which contribute to the overall WWI scores. A summary of the results is provided in Table 4, and they are illustrated in Figure 6.

**Table 4.** WWI scores for different parts of the Lower Mekong

	Minimum	Maximum	SD	Average
Cambodia	4.46	28.84	6.20	14.40
Lao PDR	9.38	26.98	5.00	16.43
Thailand	10.72	91.30	21.41	46.85
Viet Nam	0.03	28.55	9.80	18.50

On this basis, from Figure 6 we can see that within the Mekong Basin, there is some variation on this measure, and it does seem possible to differentiate between different areas of the basin for monitoring or planning purposes. At this stage, these scores cannot be taken as definitive, as some refinement of the data may still be possible; however they are a good example of how data combined from different sources can generate useful information.

**Figure 6.** Mapping WWI values in the Mekong Basin

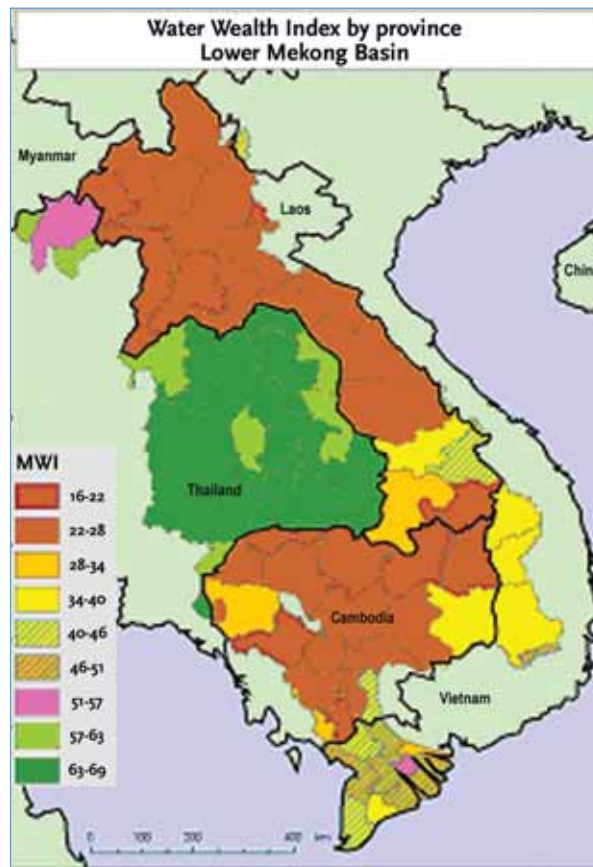

Figure 6 illustrates the variability of the WWI scores across the lower Mekong Basin; comparisons of the various element scores in different countries within the basins are provided in Table 5.

Table 5. Variations in WWI component scores for four countries in the Lower Mekong

Country	NBE	Food	Environment	Health	Capacity	Productivity
Cambodia	0.234	22.44	36.40	28.88	25.34	15.88
Lao PDR	0.216	32.86	28.54	35.19	29.26	5.69
Thailand	0.275	80.85	53.80	91.63	88.99	1.81
Viet Nam	0.426	39.56	48.88	68.80	60.94	0.87

Table 5 shows the average provincial values for the six elements of the WWI in four countries of the lower Mekong; the water endowments for each country are expressed as the Natural Baseline Endowment shown in Figure 7. Figure 8 shows how the other five elements compare between the four countries.

Figure 7. Comparing water endowments in four countries of the lower Mekong

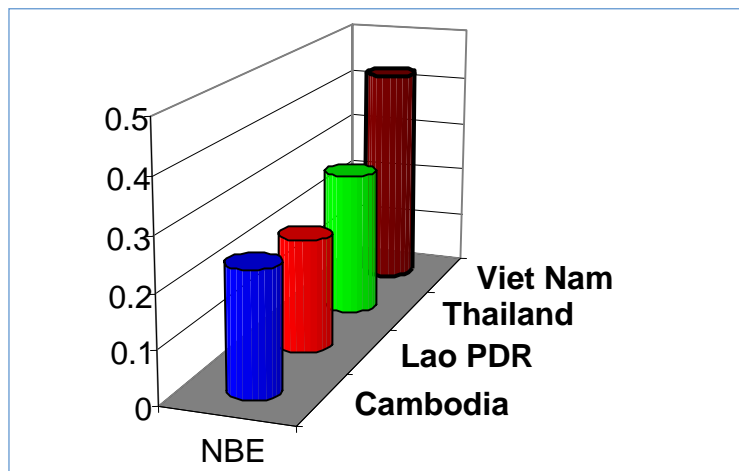
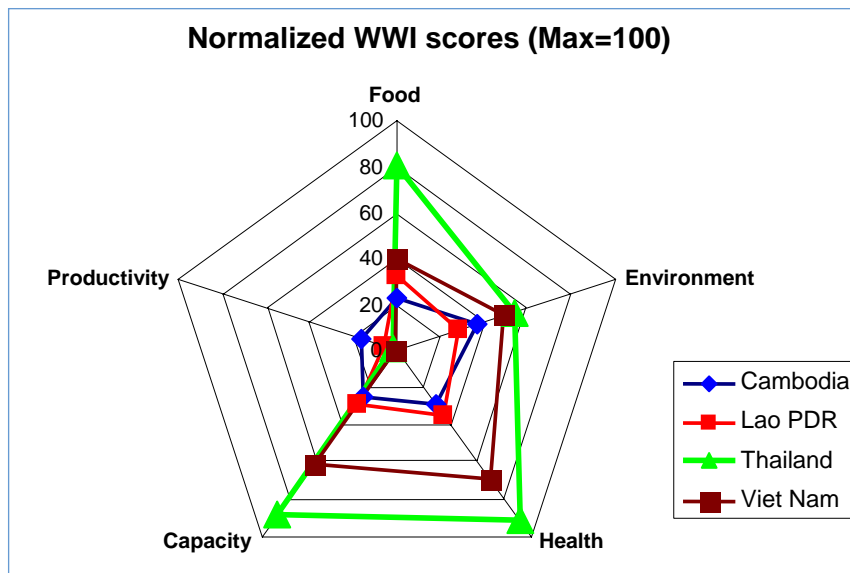

Figure 8. Individual WWI element scores in four Mekong basin countries





The very low scores on the productivity component in all countries suggest that variables used in this indicator may not be as reliable as others. There is a clear need to investigate this further, and consider how this particular element can be best represented in a more robust manner. This point is included here to emphasize the fact that this report represents work in progress and improvements in the methodology can be made through an iterative process, with practical applications of the tool tested in various locations. In addition to the figures above, the information from this type of analysis can also be displayed more figuratively, as shown in Figure 9.

**Figure 9.** *Displaying WWI information to stakeholders: interpretation of WWI scores for selected parts of the lower Mekong Basin (blue, red and green represent 3 different provinces in the basin)*

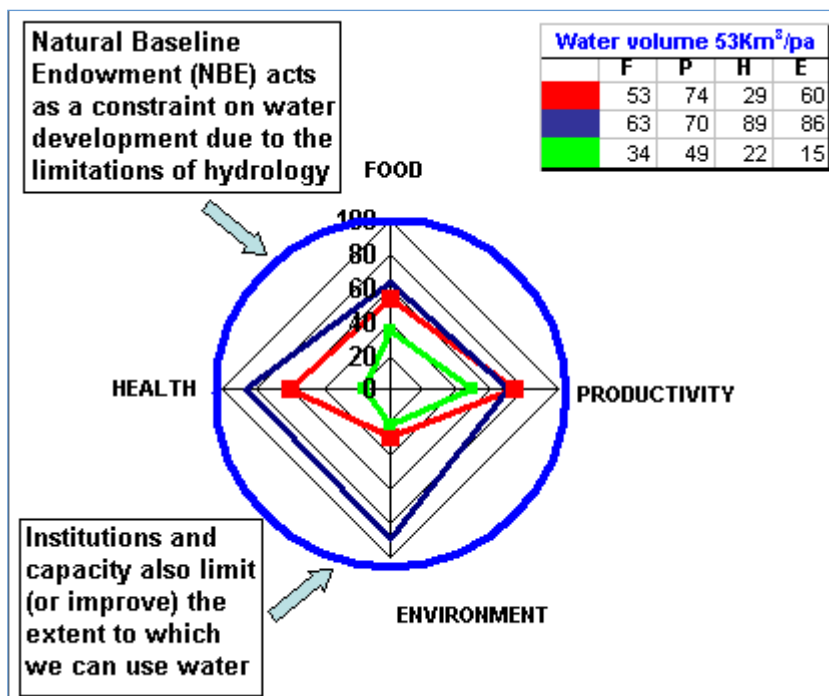

In Figure 9, the Natural Baseline Endowment (NBE, represented by the outer circle) is calculated to be 53 km<sup>3</sup>/pa for the three provinces used as examples. Within this limiting constraint however, and that imposed by different capacities, there are clear differences in how the three provinces perform in terms of the WWI, as it is represented by the variables used in these calculations.

**Box 2. Methodological note**

The mathematical structure of the WWI is currently under refinement; it is planned to combine the major components harmoniously and geometrically. This will avoid the "lumping" which occurs when a simple mathematical mean is used, and will put more emphasis on those components which by their weakness, limit performance. The output of this part of the formula will then be constrained to represent the limitation put on water allocation and use, by the degree of water availability itself (or lack of it).

In the structure of the formula, the imposition of the condition that

$$w_f + w_h + w_p + w_i + w_e = 1$$

will have the effect of creating a trade-off between the elements. Ideally, weightings should be calculated in a transparent and participatory manner, representing a variety of stakeholders' views. To achieve this, it must be noted that the weightings have to be chosen in such a way that their sum is always equal to 1.

**6.6 A longer term alternative: the Water Vulnerability Matrix**

To ensure openness to other approaches and varieties of measurement that may be more effective as tools to obtain a comprehensive and meaningful indicator set, the conceptualization work focused on flexibility and not becoming fixed on one specific concept. For example, an alternative structure was proposed, based on moving away from the term poverty as a descriptor of the measure, and moving towards a matrix-type structure as opposed to an index, as shown in Figure 10 (and Appendix 7). This structure was called the Water Vulnerability Matrix (WVM); it was proposed to incorporate the idea that water provides ecosystem services, which per se are assets that benefit human beings. While the vulnerability of aquatic ecosystems may be increased as a result of human impact, it is also true to say that the degree of health of aquatic ecosystems effectively acts as a constraint on human activity. This matrix was constructed to achieve a balance between these two opposing drivers of change.

**Figure 10. The structure of the WVM**

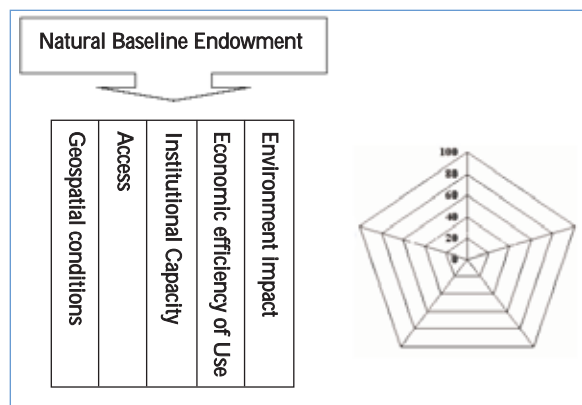

In terms of the medium- and long-term work on an indicator set which could be used to develop a WVM, a number of issues can be identified:

- The basis of chosen parameters and variables has to be continuously rechecked and improved. While some parameters are already available and suitable, AND can be used immediately in the CPWF-focused WWI, there is a need to find improved variables for a number of parameters. It is important to ensure that variables used do represent the issue selected to represent specific parts of the water system. This is especially true of socio-economic parameters.
- In particular, the capacity component as it is identified at the moment is very weak. This is partly due to a lack of recognition of the real importance of this issue, and a general weakness and under-representation of such factors in indicator sets. Major work has to be devoted to a proper definition of capacity as it relates to water management, and how this capacity is built. It has to be decided which institutional aspects of the system need to be well represented in this category. It may also be that a separate category is needed on institutions, and discussion is needed on which variables can best represent the underlying system. It was unanimously decided that the institutional dimension is a very relevant and important aspect to be included, but much more work is needed to capture such fuzzy issues as participation, social learning and cooperation, and to generate data on these issues at the appropriate scale.
- A further development from the existing tool would be to integrate different resource settings into the WVM. For realistic comparisons to be made, it is important to consider the specific water-resource setting in which that system has to work. Up to now this problem has not been solved properly and further conceptual work is needed. A first promising approach is to have a specific resource setting as a cross-cutting constraint within the WVM. This enables an investigator to compare different systems within a comparable resource setting, although the representation of different resource settings has to be worked out in the future.
- As the different categories of the concept are highly interlinked and interdependent, it is necessary to identify existing linkages and direction of dependency between categories and/or parameters. These factors are highly controversial and subjective. Furthermore, some of these linkages and dependencies are not the same within all systems, and as a result can differ widely. Therefore, as far as possible, it is appropriate to implement this scientific work within the context of stakeholder interaction. This could be possible on a basin scale, but is not likely to be possible on a global scale. For the global scale, an integration of basin results may be appropriate in the long term. In the short term, the issue of these linkages has to be worked out through scientific discourse.
- Last but not least, it will be important to develop acceptance of an appropriate name for such an indicator set and the term Water Vulnerability Matrix will need to be tested as a concept within the appropriate community of researchers and end users.

## 7. THE WAY FORWARD

The workshop participants agreed that there is a need to consider objectives, activities and progress, in two different time frames:

### 7.1 Immediate

Many other issues could have been analysed during this workshop, but the purpose was to focus on a few selected topics. The immediate next step is to hold a further meeting to work on a proposal for additional work, possibly strengthening this effort by including additional partners. Possible additions could include WRI, WHO and FAO. Some possibilities for additional funding sources might include the Challenge Programme itself, UNESCO, IFAD or other national or international donor agencies. Progress made during this workshop suggests that further funding is warranted.

### 7.2 Medium to longer term

In the medium term, there is a need to develop better understanding of relationships between conditions (states) and indicators which can be used to represent them. Ideally there is potential to produce a more dynamic model to be used as part of the WVM. In particular, there is a need to specifically address key issues which are under-represented currently. Some of these are discussed below.

#### *Capturing the environment component*

The development of environmental flow indicators is a fast-track activity for the GWSP and is currently underway in collaboration with the Global Rivers Sustainability Project (GRSP). To meet the broader needs for environmental indicators to assess "water wealth" at the global scale, we propose an expanded project that would also consider indicators for connectivity, land use and biodiversity.

#### *Flow indicators*

The GRSP/GWSP fast-track project aims to:

- Agree on an important set of hydrological parameters that are ecologically relevant
- Identify which of these can be modelled at the global scale
- Determine how much these parameters can be changed without major impact on river ecosystems
- Determine how this is likely to vary between biomes and climatic regions

A conceptual paper has already been prepared for submission to Environmental Management. A second workshop was held in Colorado in June 2005.

### ***Connectivity/fragmentation***

Data on major dams could be obtained from Nilsson et al. (2005), Vörösmarty et al. (2003), or from the data sets prepared for the World Commission on Dams report. These data could be used to calculate fragmentation indices for whole basins and/or sub-catchments. We also need to be able to identify major floodplain areas in river basins and obtain data on the land use within these areas (e.g. Tockner and Stanford 2002).

### ***Land use/water quality***

A more detailed analysis of land-use pressure (e.g. agriculture [%], urban [%]) needs to be undertaken. This would have to identify the area of land use (as a % catchment area) above each river node in the channel network, possibly adjusting for the precipitation and/or discharge at that point. Additional data sets on salinized lands and/or salinity hazard mapping would also be desirable, especially for addressing sustainability issues in the more arid regions of the world. Sediment load data (Syvitski et al. 2005) for each sub-catchment would also be desirable. National data sets are currently available for some countries (e.g. Australian Land and Water Audit).

### ***Biodiversity***

Global analyses of freshwater biodiversity are currently being addressed within the DIVERSITAS freshwaterBIODIVERSITY Cross-cutting Network. Data sets on, inter alia, biodiversity loss and threatened species are being developed within this programme. These could be included as environmental indicators for the GWSP project. Data sets on world fisheries may also be useful for comparisons of major river basins. Ideally, they would need to distinguish between freshwater and marine fisheries; however, it is important to note that many coastal fisheries are dependent on river discharges (Loneragan and Bunn 1999).

Topics which would merit further attention in the future could include:

- Institutional effectiveness – crucial for managing and allocating water resources in a sustainable way
- Floods – what is the best way to deal with the problem of global flood information, their classification and prediction?
- What would be the best way to deal with groundwater given current uncertainties and data coverage?
- How can water productivity be better captured?
- Can a measure of water re-cycling serve as an indication of stress?
- How can more explicit links to biodiversity and ecology be made?
- Addressing scaling challenges
- Data quality assurance

- More detailed spatially distributed land-use data would be very helpful in many situations
- The development of an indicator structure based on a matrix rather than an index needs to be considered

### ***Relevance to the Challenge Programme on Water and Food***

Based on the discussions and initial output from the workshop on water indicators, the use of a revised WPI (to be renamed the WWI) as an indicator for the nine Challenge Programme basins seems promising. The conceptual framework for the revised WPI includes food as a major component, and includes other components that focus on the major areas of importance of the CPWF (e.g. health and water productivity).

Preliminary results for the Mekong Basin were completed during the workshop. Although some additional data is needed for a final index, from the initial analysis, the restructured WWI appears to be a useful monitoring and discriminating tool for the CPWF. In order to investigate this possibility further, it will be necessary for the CPWF to determine what data are available at a sub-basin scale (probably the provincial level for socio-economic data). Provincial level data could then be used to calculate a WPI for each of the nine CPWF basins and could be shared with the GWSP group to include higher resolution data for some variables not currently included in their database.

Overall we can conclude that the work carried out in this workshop has demonstrated that there is much value in developing a structured composite index to be used as a tool for assessing the baseline status, and subsequent progress, both within and between the nine Challenge Programme basins.

## 8. CONCLUSIONS

The workshop successfully achieved its objectives. Useful work was carried out to investigate the potential of using the WPI framework to provide a structure which could be of use to the Challenge Programme. In addition, practical testing of the Global-RIMS tool was successfully carried out and useful products were generated.

It is judicious to reflect at this point on who wants this kind of information and to consider how it could be of use. Not only would it be of use to water managers facing urgent questions of resource prioritization, but politicians could also use this kind of knowledge to implement more effective policies, with the needs of various user groups determining the appropriate scale of application. While conceptual and geographical testing are both possible, it is important to build in traceability, to consider how issues can be related at different scales. It would also be important to develop consensus, and where possible involve key stakeholders in further refinement of these water assessment tools. For the purpose of normalization of the data, it would be useful to set a standard limit for the maximum and minimum values used for the reference range. This would need to be determined by consultation and literature searches. In addition, other combination techniques should be tried to find the most reliable mathematical structure for such an integrated indicator approach.

It is clear that there is much interest in the development of holistic interdisciplinary tools for use in Integrated Water Resources Management (IWRM). The current global commitment to this and pressure resulting from requirements, for example from the EU Water Framework Directive, have given rise to more urgency in the search for effective tools for basin level application. The outputs of this workshop have demonstrated how the advantages of increased computing power and novel interdisciplinary frameworks can generate useful water management information, providing support for decision-making. It is important to note however that the work described in this report is but a start in a process which must be seen as iterative. There is still much to be done to examine in more detail the various issues underlying these integrative techniques. Data consolidation and validation, statistical robustness of causal relationships underlying the indicator framework and refinement of the approach are all needed before the techniques outlined here can be considered ready for practical use. Data weaknesses and regional variability need to be addressed and although water trade balance could be useful, information is not sufficiently refined and reliable data sources have not been secured. The selection of a matrix or indicator structure ideally should be determined with input from end users and stakeholders. It has to be borne in mind however that any matrix or index used will be weighted by the scale of the indicators used to compile them.

## REFERENCES

- Allan, J.D. 2004. Landscapes and riverscapes: The influence of land use on stream ecosystems *Annual Review of Ecology, Evolution and Systematics*, 35: 257–84.
- Bunn, S.E. & Arthington, A.H. 2002. Consequences of altered hydrological regimes for aquatic biodiversity. *Environmental Management*, 30: 492–507.
- Green, P., Vörösmarty, C.J., Meybeck, M., Galloway, J. & Peterson, B.J. 2004. Pre-industrial and contemporary fluxes of nitrogen through rivers: A global assessment based on typology. *Biogeochemistry*, 68: 71–105.
- GWSP (Framing Committee of the GWSP). 2005. *The Global Water System Project: Science framework and implementation activities*. Bonn, Germany, Earth System Science Partnership. Available online at [www.gwsp.org](http://www.gwsp.org).
- Junk, W.J., Bayley, P.B. & Sparks, R.E. 1989. The flood pulse concept in river-floodplain systems. *Canadian Special Publication of Fisheries and Aquatic Sciences*, 110–127.
- Loneragan, N.R. & Bunn, S.E. 1999. River flows and estuarine ecosystems: Implications for coastal fisheries from a review and a case study of the Logan River, southeast Queensland. *Australian Journal of Ecology*, 24: 431–440.
- Malmqvist, B. & Rundle, S. 2002. Threats to the running water ecosystems of the world. *Environmental Conservation*, 29: 134–153.
- Molden, D. 2003. Pathways to improving the productivity of water. *In* Issues of water management in agriculture: compilation of essays, pp. 1–6. Colombo, Sri Lanka, Comprehensive Assessment of Water Management in Agriculture.
- Nilsson, C., Reidy, C.A., Dynesius, M. & Revenga, C. 2005. Fragmentation and flow regulation of the world's large river systems. *Science*, 308: 405–408.
- Postel, S. & Richter, B. 2003. *Rivers for life: managing water for people and nature*. Washington, Island Press.
- Pringle, C.M. 2001. Hydrologic connectivity and the management of biological reserves: A global perspective. *Ecological Applications*, 11: 981–998.
- Sullivan, C.A. 2001. The potential for calculating a meaningful Water Poverty Index. *Water International*, 26: 471–480.
- Sullivan, C.A. 2002. Calculating a Water Poverty Index. *World Development*, 30: 1195–1210.
- Sullivan, C.A., Meigh, J.R. & Fediw, T. 2002. *Developing and testing the Water Poverty Index: Phase 1 Final Report*. Report to Department for International Development, Centre for Ecology and Hydrology, Wallingford, UK.
- Sullivan, C.A., Meigh, J.R., Giacomello, A.M., Fediw, T., Lawrence, P., Samad, M., Mlote, S., Hutton, C., Allan, J.A., Schulze, R.E., Dlamini, D.J.M., Cosgrove, W., Delli Priscoli, J., Gleick, P., Smout, I., Cobbing, J., Calow, R., Hunt, C., Hussain, A., Acreman, M.C., King, J., Malomo, S., Tate, E.L., O'Regan, D., Milner, S. & Steyl, I. 2003. The Water Poverty Index: Development and application at the community scale. *Natural Resources Forum*, 27: 189–199.



- Sullivan, C.A. & Meigh, J.R.** 2003. The Water Poverty Index: its role in the context of poverty alleviation. *Water Policy*, 5: 5. Oct 2003.
- Sullivan, C.A. & Meigh, J.R.** 2005. Targeting attention on local vulnerabilities using an integrated indicator approach: the example of the Climate Vulnerability Index. *Water Science and Technology*, Special Issue on Climate Change (51: 5).
- Sullivan, C.A., Meigh, J.R. & Lawrence, P.** 2006 (in press). Application of the Water Poverty Index at different scales: a cautionary tale. *Water International*, Special Issue.
- Syvitski, J.P.M., Vorosmarty, C.J., Kettner, A.J. & Green, P.** 2005. Impact of humans on the flux of terrestrial sediment to the global coastal ocean. *Science*, 308: 376–380.
- Tockner, K. & Stanford, J.A.** 2002: Riverine flood plains: present state and future trends. *Environmental Conservation*, 29 (3): 308-330.
- Vörösmarty, C.J., Leveque, C. & Revenga, C.** (Convening Lead Authors). 2005a. Fresh water. In *Millennium ecosystem assessment, Volume 1: Conditions and trends*. Working Group Report. Island Press.
- Vörösmarty, C.J., Douglas, E.M., Green, P.A. & Revenga, C.** 2005b. Geospatial indicators of emerging water stress: An application to Africa. *Ambio*, 34: 230-236.
- Vörösmarty, C.J., Meybeck, M., Fekete, B., Sharma, K., Green, P. & Syvitski, J.** 2003. Anthropogenic sediment retention: Major global-scale impact from the population of registered impoundments. *Global Planetary Change*, 39: 169–190.
- Vörösmarty, C.J.** 2002. Global water assessment and potential contributions from earth systems science. *Aquatic Sciences*, 64: 328–351.
- Vörösmarty, C.J., Green, P., Salisbury, J. & Lammers, R.** 2000. Global water resources: Vulnerability from climate change and population growth. *Science*. 289: 284–288.
- Wallace, J.S., Acreman, M.C. & Sullivan, C.A.** 2003. The sharing of water between society and ecosystems: from advocacy to catchment based co-management. *Philosophical Transactions of the Royal Society of London*, B Biology Dec 2003, 513–528.
- WHO/UNICEF.** 2004. *Meeting the MDG drinking water and sanitation target: A mid-term assessment of progress*. World Health Organization (Geneva) and United Nations Children’s Fund (New York). 33 pp.

## APPENDIXES

### Appendix 1. List of Participants

**Table A1.** *Participants at the Wallingford Meeting on Water Indicators  
Wallingford, 16–19 May 2005*

Name	E-mail	Main Institution
Caroline Sullivan	csu@ceh.ac.uk	CEH Wallingford
Charles Vörösmarty	charles.vorosmarty@unh.edu	U. New Hampshire
Eric Craswell	eric.craswell@uni-bonn.de	U. Bonn (GWSP)
Deborah Bossio	d.bossio@cgiar.org	IWMI
Sarah Cline	s.cline@cgiar.org	IFPRI
Adam Storeygard	astoreyg@ciesin.columbia.edu	CIESIN
Alex Prousevitch	alexp@plato.sr.unh.edu	U. New Hampshire
Ellen Douglas	ellen.douglas@unh.edu	U. New Hampshire
Claudia Heidecke	heidecke@agp.unibonn.de	U. Bonn (GLOWA Impetus)
Stuart Bunn	s.bunn@griffith.edu.au	U. Griffith
Dirk Günther	dirk.guenther@usf.Uni-Osnabrueck.de	U. Osnabrück
Richard Harding	rjh@ceh.ac.uk	CEH Wallingford
Dermot O'Regan	dpo@ceh.ac.uk	CEH Wallingford
Eleanor Blyth	emb@ceh.ac.uk	CEH Wallingford
Virginie Keller	vke@ceh.ac.uk	CEH Wallingford
Roger Moore	rvm@ceh.ac.uk	CEH Wallingford
Anna Maria Giacomello	amgi@ceh.ac.uk	CEH Wallingford

## Appendix 2. Agenda

**Water Indicators: Mapping the Links between Water,  
Poverty and Food Security**  
Centre for Ecology and Hydrology, Wallingford  
16–19 May, 2005

**SUNDAY, 15<sup>th</sup>** Dinner for those present in the hotel

**MONDAY, 16<sup>th</sup>**

**09.30** Welcome and introductions

**10.00–12.30**

**Session 1. Chair Eric Craswell – Objectives of the meeting**

Overview of GWSP aspirations CV

Overview of CPWF aspirations SC

Integrated indicators, or an indicator matrix? CS

Data

Group discussion

Discussant: RH (to provide summary in day's final session)

**12.30–13.30** Lunch

**13.30–15.00**

**Session 2. Chair: Richard Harding**

**Modelling water, food and poverty components – points to consider** (10 minutes on each topic followed by discussion)

Resources: CV

Access: ED

Poverty measures: CS

Use: DB

Capacity: CS

Env: SB

WQ: VK

Food Security: SC

Climate: EB

Group discussion – identify other themes

Discussant: RM (to provide summary in day's final session)

**15.00–15.30** Tea

**15.30–18.00** Conceptual review and discussion

Sessions 1 and 2 review

Open discussion



## TUESDAY, 17<sup>th</sup>

### 08.30–10.00 Session 3. Chair: Caroline Sullivan

- CEISIN data AS
- Demo of indicator system(s): UNH
- WPI application to CPWF basins CH
- Discussion

*Sarah Cline to provide feedback report at the final session of the day*

10.00–10:30 Coffee – Create working groups

10:30–12.30 Working group discussions (conceptualization and modelling)

12.30–13.30 Lunch

13.30–15.15 Working group discussions (conceptualization and modeling)

15.15–15.30 Tea

15.30–16.30 Presentation by CV '*News flash: Humans changing the Earth's system*'

### 16.30–18.00 Session 4 Chair: Deborah Bossio

- data issues - group discussion
- strategy for Wednesday and Thursday

20.00 Dinner at a local country pub

## WEDNESDAY, 18<sup>th</sup>

09.00–12.30 Small group work, brainstorming, data manipulation

12.30–13.30 Lunch

13.30–15.00 Small group work, brainstorming, data manipulation

15.00–15.30 Tea

15.30–17.00 Whole group modeling session

## THURSDAY, 19<sup>th</sup>

09.00–12.30 Small group work, brainstorming, data manipulation

12.30–13.30 Lunch

13.30–15.00 Brief updates from each group (problems, successes)

15.00–15.30 Tea

15.30–17.00 Final group session – output development

## Appendix 3. Overview of the Global Rapid Integrated Monitoring System (Global-RIMS) (copyright 2005/2006, University of New Hampshire)

### A3.1 A GLOBAL RAPID INTEGRATED MONITORING SYSTEM FOR WATER CYCLE AND WATER RESOURCE INDICATOR ASSESSMENT (Global-RIMS)

The development of the Global Rapid Integrated Monitoring System (G\_RIMS) has been funded in part by the National Aeronautics and Space Administration (NASA), the United Nations Educational, Scientific, and Cultural Organization (UNESCO) and by the United Nations Environment Programme (UNEP). The original proto-type was implemented as the Data Synthesis System for World Water Resources (DSS) with funding from the World Water Assessment Program (WWAP) supported through the UNESCO International Hydrological Programme. The DSS (<http://www.wwap-dss.sr.unh.edu>) is an operational, digital information system for water resource assessment cast within a geographic information system framework accessible via the World Wide Web. The system includes a broad suite of spatial and statistical data encompassing point scale and gridded socioeconomic and biogeophysical products for data exploration and download. This data are organized according to water indicator themes and are presented in the spatial context of the river basin to analyze the changing nature of water in relation to human needs and activities at the global, regional and case study scales.

The DSS framework was utilized in the development of the global River Basin Information System (RBIS) prototype, which was commissioned in 2001 by the UNEP Division of Early Warning and Assessment (DEWA) to identify impacts and challenges of global change within selected, key watershed of the world. Using a common framework and methodology, the RBIS was cast to analyze the impacts of global change using a variety of spatial perspectives including the capability to analyze global, continental, regional, river basin and country conditions. It thus provides a framework to perform comparative broad-scale assessments while also serving to enrich country-level and case study work. RBIS, version 1 (RBIS v1) was intended as a preliminary phase in exploring global change impacts and challenges on a limited scale, focusing initially on selected, key basins and a subset of relevant data themes derived from the TYGRIS (Typology of Global River Systems) toolbox. RBIS v1 operates at a 30' (latitude x longitude) for the global sub-domains. The most recent RBIS version (RBISv2, <http://rbis-unesp.sr.unh.edu>) offers a 6' (latitude x longitude) resolution as well as dynamic and interactive functionality for assessing the temporary state of African river basins. RBISv2 offers expanded functionality including zooming capabilities, interactive map query, display and calculation of upstream basin statistics, data layer calculator for user-generated calculations, generating upstream statistics "on the fly", time series animations and graphs, maps of monthly and annual climatologies, and names and locations of major cities.

The current Global-RIMS expands RBISv2 data holdings to include regional, continental and global datasets at resolutions from 6' to 30' (latitude x longitude) and utilizes a display pyramid approach. For the specific needs of the GWSP, the Global-RIMS software has been developed by Alex Prusevich (UNH). It has four main functionality features (described below).

### A3.2 Data mounting system

The system can read the most common GIS data exchange format as ArcInfo GridAscii file format. Mounting system specifications include:

- a) Arbitrary geographical area of coverage. The system can accept global as well as regional datasets.
- b) Any type of data resolution.
- c) Geographical projection.

### A3.3 Data preprocessing system

The datasets have to be converted to binary format for fast access and reading, and incorporated to efficient data-query system that is capable virtually instantly to retrieve data for map or graph building, while simultaneously performing calculations.

### A3.4 Data navigation and display system

The display system is capable to interface with a user via a web browser. A user can choose a dataset and navigate it in any part of its geographical scope (zoom-in, zoom-out, pan, custom area selection, etc.). A set of viewing help tools displays many optional functionalities that can handle animation of time series data, graphing, upstream catchment area selection, etc. An example of this is shown in Figure A3.1.

Figure A3.1. A screen shot of the data navigation and display section of Global-RIMS

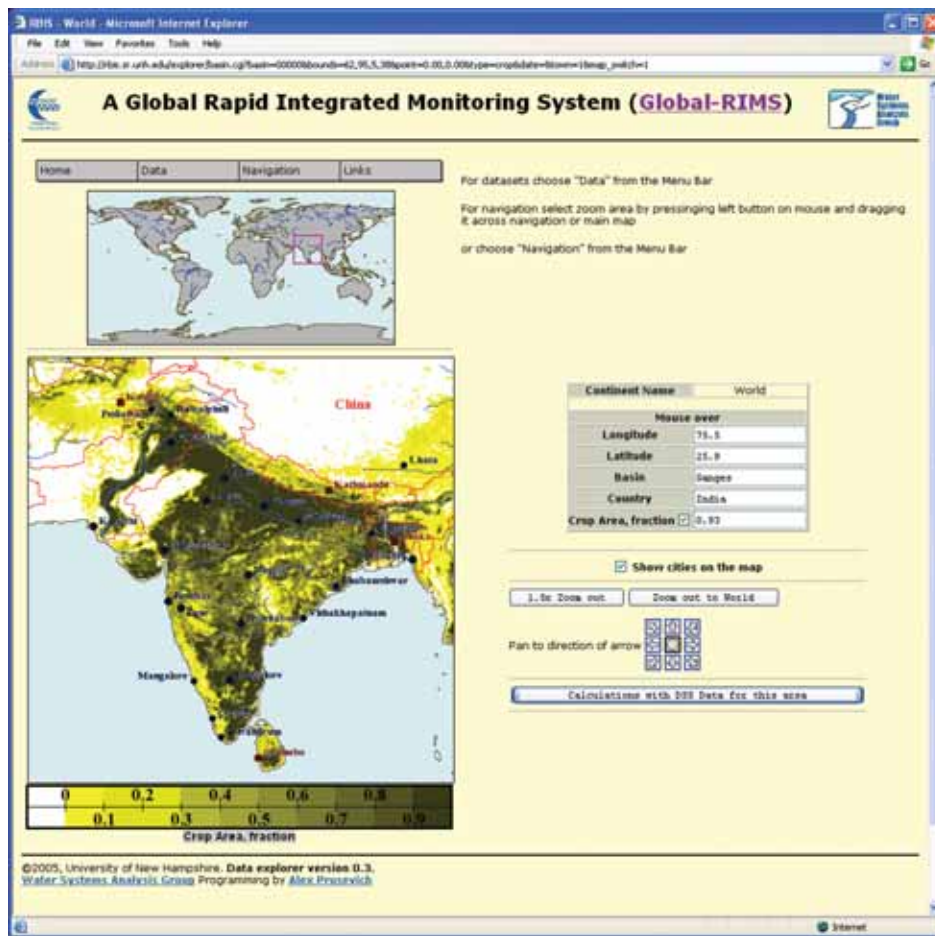

©2005, University of New Hampshire

### A3.5 Data calculation and manipulation system

Simple and sophisticated calculations with gridded datasets could be performed via the web interface. Each dataset gets assigned to it algebraic symbols that could be used to perform any arbitrary equation over each grid cell in the selected area. In addition, the calculation system is capable to do integration of an arbitrary expression over map areas, and display a basic statistical summary of the calculated values. The results of the calculations are displayed as maps, distribution histograms, and a statistical summary. An example of this is shown in Figure A3.2.



Figure A3.2. A screen shot of Global-RIMS in the data calculation and manipulation section

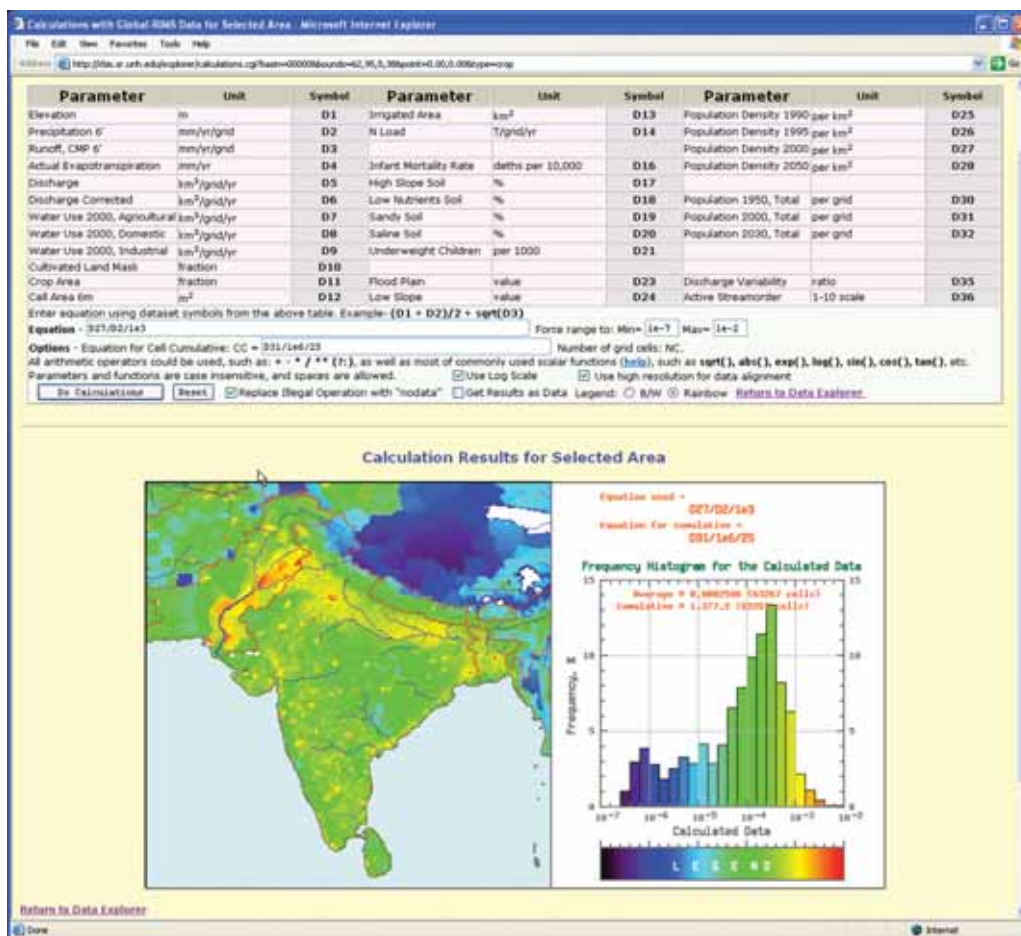

©2005, University of New Hampshire

Since the Global-RIMS software is a new product of UNH Water Systems Analysis Group, which has not yet been used for practical application, Dr. Prusevich carried out training of the participants in the system use, and also provided technical support in the system modification and debugging during the GWSP workshop. Important additions to the system have been made in the effort to accommodate computational needs to produce desired calculations, and displaying their results.

## Appendix 4. Global-RIMS indicator development table

This provides a definition and the necessary codes to calculate and display selected combinations of variables that were tried out by the workshop group. This is just a small sample to illustrate what is possible.

**Table A4.1.** *Global-RIMS indicator development table*

Indicator	Computation	Global-RIMS equation	Image file	Values
<b><i>Cropland intensity (fraction of total cell area) on high slopes</i></b> (Constrain by cropland area > 15% of total cell area)	Crop area (fraction) x cellarea (m <sup>2</sup> )/1e6 (m <sup>2</sup> /km <sup>2</sup> ) x high slope (%)/100/[cell area (m <sup>2</sup> )/1e6 (m <sup>2</sup> /km <sup>2</sup> )]	d11>0.15?d11*d17/100:-9999	Pop on cropland with high slopes.png	Mekong: 1,156,000 people Karkheh: 92,100 Krishna: 2,319,000
<b><i>Total population on croplands with high slopes</i></b> (Constrain by cropland area > 15% of total cell area)	Popdensity (people/km <sup>2</sup> ) x cellarea (m <sup>2</sup> )/1e6 x crop area (fraction) x high slope (%) /100	d27*d11*d12*d17/1e8		
<b><i>Cropland intensity (fraction of total cell area) on low nutrient soils</i></b> (Constrain by cropland area > 15% of total cell area)	Crop area (fraction) x cellarea (m <sup>2</sup> )/1e6 (m <sup>2</sup> /km <sup>2</sup> ) x low nutrients (%)/100/[cellarea (m <sup>2</sup> )/1e6 (m <sup>2</sup> /km <sup>2</sup> )]	d11>0.15?d11*d18/100:-9999	Pop on croplands with low nutrients.png	Mekong: 8,044,000 people Karkheh: None Krishna: 2,257,000
<b><i>Total population on croplands with low nutrient soils</i></b> (Constrain by cropland area > 15% of total cell area)	Popdensity (people/km <sup>2</sup> ) x cellarea (m <sup>2</sup> )/1e6 x crop area (fraction) x low nutrients (%)/100	d27*d11*d12*d18/1e8		
<b><i>Cropland intensity (fraction of total cell area) on sandy soils</i></b> (Constrain by cropland area > 15% of total cell area)	Crop area (fraction) x cellarea (m <sup>2</sup> )/1e6 (m <sup>2</sup> /km <sup>2</sup> ) x sandy soils (%)/100/[cell area (m <sup>2</sup> )/1e6 (m <sup>2</sup> /km <sup>2</sup> )]	d11>0.15?d11*d19/100:-9999	Pop on croplands with sandy soils.png	Mekong: 730,000 Karkheh: none
<b><i>Total population on croplands with sandy soils</i></b> (Constrain by cropland area > 15% of total cell area)	Popdensity (people/km <sup>2</sup> ) x cellarea (m <sup>2</sup> )/1e6 x crop area (fraction) x sandy soils (%)/100	d27*d11*d12*d19/1e8		

<p><b>Cropland intensity (fraction of total cell area) of croplands on saline soils</b> (Constrain by cropland area &gt; 15% of total cell area)</p>	<p>Crop area (fraction) x cellarea (m<sup>2</sup>)/1e6 (m<sup>2</sup>/km<sup>2</sup>) x saline soils (%) /100] / [cell area (m<sup>2</sup>)/1e6 (m<sup>2</sup>/km<sup>2</sup>)]</p>	<p>d11&gt;0.15?d11*d20/100:-9999</p>	<p>Pop on croplands with saline soils.png</p>	<p>Mekong: 90,600 Karkheh: 27,900 Krishna: 11,524,000</p>
<p><b>Total population on croplands with saline soils</b> (Constrain by cropland area &gt; 15% of total cell area)</p>	<p>Popdensity (people/km<sup>2</sup>) x cellarea (m<sup>2</sup>)/1e6 x crop area (fraction) x saline soils (%) /100</p>	<p>d27*d11*d12*d20/1e8</p>		
<p><b>Agricultural pressure (km<sup>2</sup> of cropland per km<sup>2</sup> discharge)</b></p>	<p>Crop area (fraction) x cellarea (m<sup>2</sup>)/1e6 (m<sup>2</sup>/km<sup>2</sup>)/Discharge (km<sup>3</sup>/yr)</p>	<p>d11&gt;0.15?(d11*d12/1e6)/d5:-9999</p>	<p>Ag_pressure_cropland_per_discharge.png</p>	
<p><b>Agricultural water crowding (2000 population per km<sup>3</sup> precip falling over croplands)</b></p>	<p>Popdensity (people/km<sup>2</sup>)/[precip (mm/yr) x crop (fraction)/1e6]</p>	<p>d11&gt;0.15?d27/(d2*d1/1e6):-9999</p>	<p>Ag_water_crowding.png</p>	
<p><b>Total population (1990)</b></p>	<p>Popdensity (people/km<sup>2</sup>) x cellarea (m<sup>2</sup>)/1e6</p>	<p>d25*d12/1e6</p>	<p>Population distribution.png</p>	<p>Mekong: 48,800,000 Krishna: 73,100,000</p>
<p><b>Total population (1990) over croplands</b></p>	<p>Popdensity (people/km<sup>2</sup>) x cellarea (m<sup>2</sup>) * crop area (fraction) / 1e6</p>	<p>d11&gt;0.15?d25*d12*d1/1e6:-999</p>	<p>Population distribution over croplands.png</p>	<p>Mekong: 23,300,000 Krishna: 43,800,000</p>
<p><b>Discharge per grid cell (runoff x area) in km<sup>3</sup>/yr</b></p>	<p>Runoff (mm/yr) x cellarea (m<sup>2</sup>)/1e12</p>	<p>d3*d12/1e12</p>	<p>Discharge_per_grid_km<sup>3</sup>_yr</p>	<p>Mekong:489 km<sup>3</sup>/yr(obs = 467 km<sup>3</sup>/yr)</p>
<p><b>Relative Water Stress Index (D+I+A for 2000/Q)</b></p>	<p>Domestic + Industrial + Agricultural water use (km<sup>3</sup>/yr)/ Discharge (km<sup>3</sup>/yr)</p>	<p>d5&gt;0?(d7+d8+d9)/d5:-9999</p>	<p>RWSI_2000_annual.png</p>	

## Appendix 5. Sample Map Images: Application of Global-RIMS to Selected River Basins

**Figure A5.1.** *Krishna Basin: Investigating potential food insecurity*

Database queries reveal the extent of potential food insecurity, by highlighting the huge numbers living on croplands with high salinity soils (some 11.5 million people).

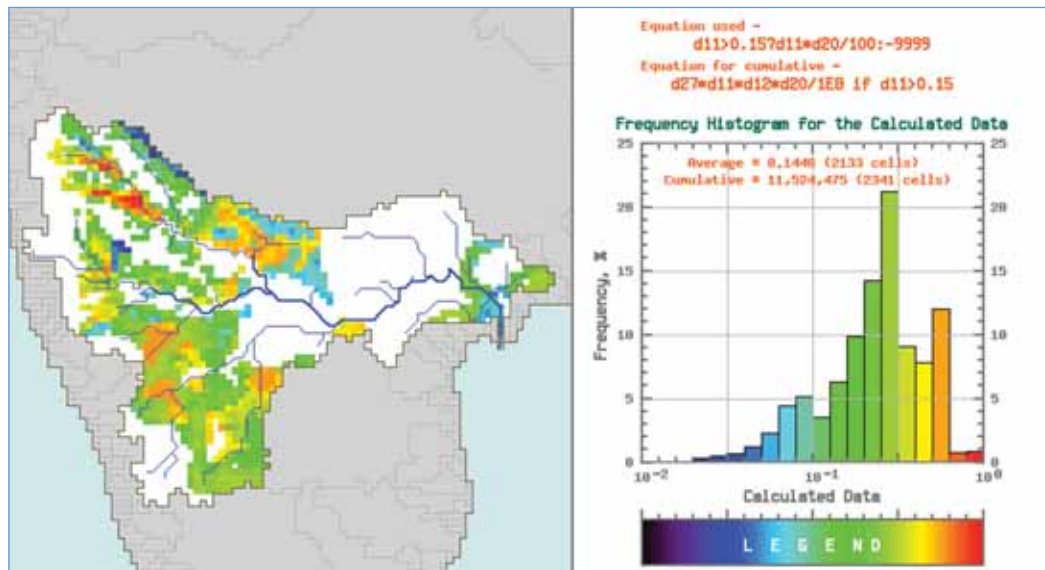

Intensity of croplands with salinity soils: Krishna River Basin. Computations constrained to cropland area > 15 percent of grid cell area. Total number of people living on high salinity cropland = 11,524,000.

**Figure A5.2.** *Low nutrient croplands in the Mekong Basin*

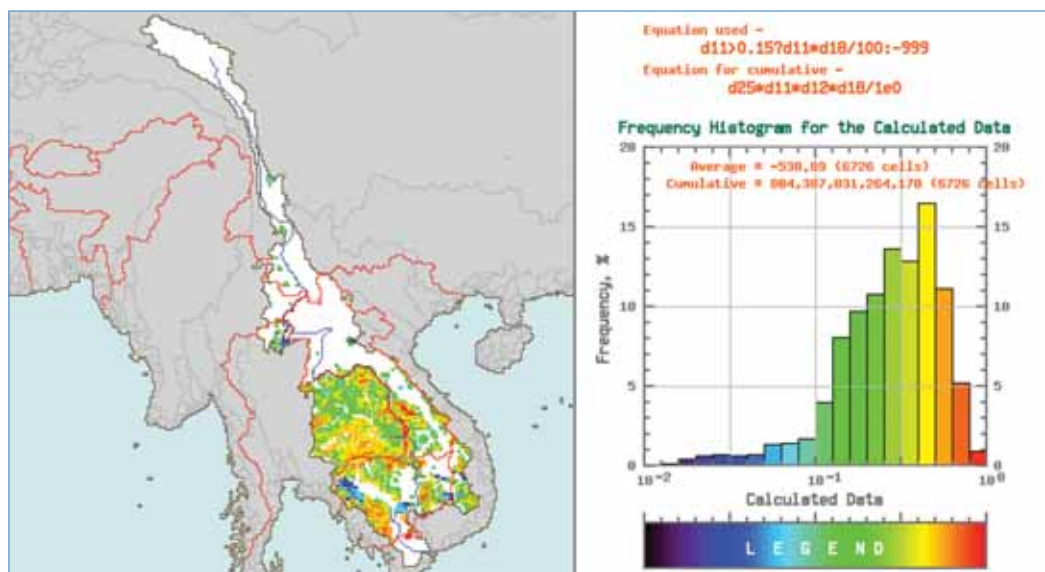

Intensity of croplands with low nutrient soils: Mekong River Basin. Computations constrained to cropland area > 15 percent of grid cell area. Total number of people living on low nutrient croplands = 8,044,000.

**Figure A5.3.** *Distribution of underweight children on poor soils in the Orange Basin in Southern Africa*

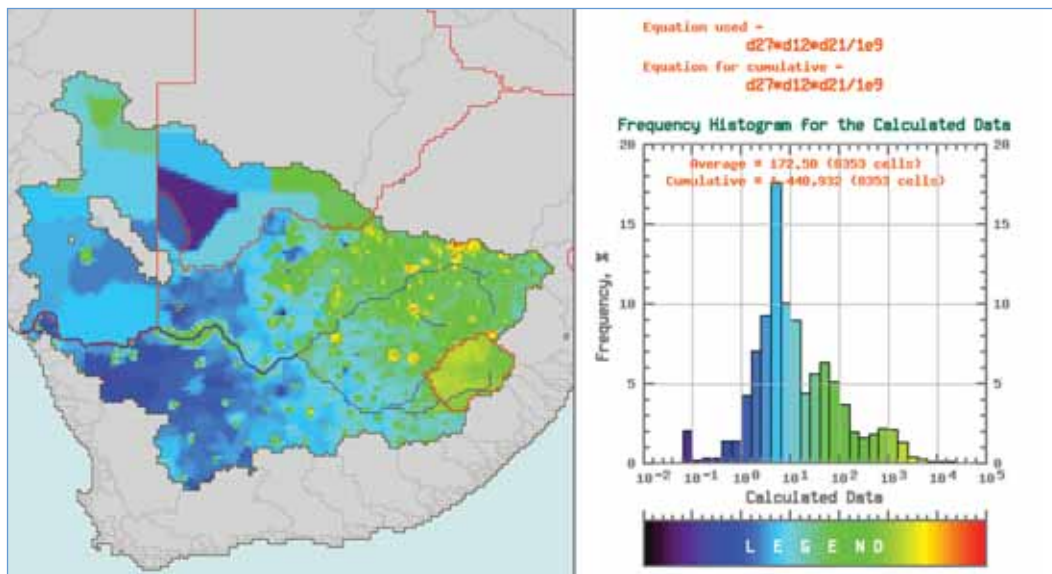

In the Orange Basin in Southern Africa, using this approach, the number of underweight children is estimated to be some 1,440,932. High percentages of these children are concentrated in the upper part of the basin, in particular in Lesotho.

These figures represent the many ways in which this type of data integration can contribute to a better understanding of pressures on water resources at the basin scale.

## Appendix 6. Comment on Variables Used to Calculate a Preliminary WWI for the Mekong Basin

As the data for many relevant variables for the Mekong Basin originate from different sources, it is likely that there may be variation in how they are both defined and measured. Some examples are provided here to illustrate how data for the same variable may vary.

### F (Food)

#### F1. Number of malnourished children<sup>3</sup>

The data on the number of malnourished children were taken from the Mekong Social Atlas of the Mekong River Commission (MRC). Overall in the Lower Mekong Basin the percentage of children under the age of five being underweight is around 30 percent (except for Thailand), even reaching up to 50 percent in upland areas or within ethnic minorities.

In northern areas of Thailand and the Korat Plateau child malnutrition is around 20 percent or less. Child malnutrition and poverty are closely related.

Data included for the provinces of each country:

**Cambodia:** Percentage of children more than two standard deviations below the mean weight for a healthy reference population (2,000)\* from: Health Survey 2000, Table 15.

**Lao PDR:** Proportion of moderately underweight children under five years (1999): Lao PDR Human Development Report, 2001.

**Thailand:** Percentage of children suffering first-degree malnutrition (1996): Ministry of Public Health, 1996.

**Viet Nam:** Underweight children under five years old (1998): Viet Nam Human Development Report, 2001, Table 2.

\* The data source amalgamates the provinces of: Battambang and Krong Pailin; Kampot, Kep and Sihanoukville; Preah Vihear, Stung Treng and Kratie; Mondul Kiri and Ratana Kiri; and Siem Reap and Otdar Meanchey.

### H (Health)

#### H1. Proportion of people with access to safe water

Quality and access to safe water vary greatly across the Lower Mekong Basin. For example in most regions in Thailand 90 percent of the population have access to safe water, whereas in most Cambodian provinces only 25 percent have safe water sources. The access rate in Lao PDR varies between 25 and 50 percent especially because of safe water

---

<sup>3</sup> Demographic data source: Hook, J., Novak, S. & Johnston, R. 2003. Social atlas of the Lower Mekong Basin. Phnom Penh, Mekong River Commission. 154 pp.. ISSN: 1727-1800.

sources in upland areas with unpolluted water sources. Vietnamese provinces in the Mekong Basin mostly lack access to safe water sources.

**Data included in the calculation:**

**Cambodia:** Percentage of households with access to either piped, tubewell, pipewell, or purchased drinking water (1998): Population Census 1998 PopMap.

**Lao PDR:** Percentage of population with piped water or protected well (1997/1998): Expenditure and Consumption Survey, 1997/1998, Table 16.

**Thailand:** Percentage of households with access to bottled drinking water, tap water, rainwater or private well (2000): Population Census, 2000, Key Ind.

**Viet Nam:** Percentage with access to safe water (1999): Viet Nam Human Development Report, 2001, Table 2.

**H2. Access to sanitation**

Sanitation facilities contribute greatly to health and longevity. Definitions of the access to sanitation differ however and the levels vary immensely across the Lower Mekong Basin. A major proportion of households in Thailand and the Mekong Delta have adequate sanitation, whereas for provinces in Lao PDR and Cambodia only 20 percent have access to sanitation facilities. Again, sanitation is much better in urban than in rural areas.

**Cambodia:** Percentage of people with flush toilets, latrines, and traditional pit latrines, with or without connection to sewer/septic tank (2000)\*: Health Survey, 2000, Table 14.

**Lao PDR:** Percentage of population with access to a toilet of any kind (1995): Population Census, 1995, Table 8.6.

**Thailand:** Percentage of households with flush latrines and moulded bucket latrines (2000): Population Census, 2000, Key Ind.

**Viet Nam:** Percentage with access to sanitation (1999): Viet Nam Human Development Report, 2001, Table 2.

**H3. Child Mortality Rate**

Death in one year per 1,000 live births.

The Infant Mortality Rate (between 75 and 125 deaths per 1,000 live births) is highest in provinces of Cambodia and Lao PDR. Here the rates are higher than the regional average. In contrast, Thailand and the Mekong Delta of Viet Nam have lower infant mortality rates than the regional average.

**Description and Source of the data used in the calculation:**

**Cambodia:** Number of deaths of children under one year of age during a year per 1,000 live births (1998): Population Census, 1998.

**Lao PDR:** The probability of dying between birth and one year of age, expressed per 1,000 live births (1995): Population Census, 1995.

**Thailand:** Infant deaths per 1,000 live births (1997): Ministry of Public Health, 1997.

**Viet Nam:** Infant mortality rate (1999): Viet Nam Human Development Report, 2001.

**IC (Institutional Capacity)****IC1. Access to electricity**

Around 80 percent of the people in Thai provinces in the Lower Mekong Basin have access to electricity. In the Korat Plateau the access rate to electricity even reaches up to 90 percent due to hydropower and thermal generating plants. Overall in Viet Nam, around 75 percent of the population has electricity (however there are differences between rural and urban areas and provinces in the Mekong Delta are below the country average). Most households in Cambodia and Lao PDR so far have no access to public electricity. Rural households without public electricity use generators or diesel motors as sources.

**Data included for the provinces of each country:**

**Cambodia:** Percentage of households that have city power, generators, or both as the main source of light (1998): Population Census, 1998, PopMap.

**Lao PDR:** Percentage of villages with electricity (1997/1998): Expenditure and Consumption Survey, 1997/1998, Table 22.

**Thailand:** Percentage of households with access to electricity (1990): Population Census, 1990, Table 10.

**Viet Nam:** Percentage with access to electricity (1999): Viet Nam Human Development Report, 2001, Table 14.

**IC2 Education**

The Female Adult Literacy Rate (proportions of literate women over the age of 15 years) varies greatly within the Lower Mekong Basin. In contrast to male illiteracy rates, female illiteracy ranges more greatly and is lower overall. The difference between literate men and women is for example higher in northern Laos whereas in northern regions of Thailand most women are literate.

Female literacy rates in the Mekong Delta are around 80 percent, in most areas of Cambodia and Lao PDR adult literacy is below 60 percent.



**Description and source of the data used in the calculation:**

**Cambodia:** Percentage of females aged 15 and over that are literate (1998): Population Census, 1998.

**Lao PDR:** The percentage of the female population 15 years and above who can read and write a simple statement (1998): Expenditure and Consumption Survey, 1997/1998.

**Thailand:** Percentage of literate female population (1995) (figures for illiterates include all females 14 years or older who did not complete Grade 4): National Education Committee, 1995.

**Viet Nam:** Percentage of literate females 15 years and over (1999): Population Census, 1999.

**E (Environment)**

**E1. Flow modification**

Detailed flow time series were not available to develop indices based on flow variability, predictability etc during the workshop. Instead, we used an indicator of “likely river flow modification”. This considered data for grid cells (10 x 10 km) only where stream order >1, and divided total water use (agriculture, domestic and industrial) by the discharge (adjusted Q) for each cell. The rationale for this indicator was that cells with a high use relative to Q are likely to have a greater modification of river flow. In turn, a high use relative to discharge is likely to be associated with low river health.

**E2. Connectivity/barriers**

In the absence of a data layer on the location of dams and weirs, we could focus only on potential impacts to lateral connectivity (i.e. access to floodplains). This considered data for cells (10 x 10 km) only where stream order >3 (i.e. the larger river sections, which are likely to have significant floodplains) and considered the fraction of each cell that was occupied by cropland.

**E3. Land use/water quality**

We were unable to undertake a detailed analysis of land use at the sub-catchment scale so that we could estimate potential impacts to river health. Instead, we considered modelled nitrogen load for grid cells (10 x 10 km) where stream order >1 (i.e. the potential N load close to the river channel network). A measure of “agricultural pressure” was also included, represented by the area of cropland divided by discharge.

**E4. Biodiversity**

Not used as no data were available for the workshop.

## Appendix 7. A suggested structure for a Water Vulnerability Matrix

Water Vulnerability
Water Policy & Management

*Using the*

# Water Vulnerability Matrix

*to assess vulnerability of water systems*

**The WVM approach**

People's vulnerability to changes in water resources depends on a combination of factors. Besides the quantity of water that is available, a range of social, economic and environmental factors affect the ability to manage water resources. Those communities and locations which are most vulnerable need to be identified in order to prioritise mitigating action. The *Water Vulnerability Matrix (WVM)* provides a novel approach to this prioritisation problem, based on a framework which incorporates a wide range of issues. It is a holistic methodology for assessing the vulnerability of water resources. It has been designed following much consultation, and is based on previous integrated indicator work (Sullivan, 2002, Sullivan et al., 2003, Sullivan and Meigh, 2005). In keeping with the sustainable livelihoods approach used by many donor organisations to evaluate development progress, this *Water Vulnerability Matrix* incorporates measures of water stress and hydrological conditions with those socioeconomic and cultural factors which give rise to vulnerability. The Matrix is based on five key characteristics which interact with each other, yet are all constrained by the background hydrological regime, referred to here as the *Natural Baseline Endowment*. Each of these characteristics is scored from 0 to 100, and the mathematical formula underlying the matrix allows for emphasis to be placed on certain issues, based on a system of weighting. The five major characteristics of the *Water Vulnerability Matrix* are shown (Table 1). This framework provides a means for comparative measurement between locations, vulnerable groups or exposure units. While the key characteristics of this framework are constant, there is built-in flexibility in the choice of individual variables. The selection of sub-characteristics/ variables should be made following consultation with local stakeholders.

Note: In order for comparisons between groups or places to be valid, the same variables need to be used in the matrix.



Characteristic	Description
Natural Baseline Endowment	The physical availability of surface and ground water, taking account of seasonal and inter-annual variability, as well as the total amount of water.
Access	The extent of access to water for: • human domestic use, • sanitation, • food production (agriculture)
Institutional Capacity	The effectiveness of institutions and society to manage water. In addition to formal laws and rights, capacity is interpreted in the sense of income to a low price or of improved water, level of education and health which interact with income and indicate a capacity to lobby for and manage a water supply.
Economic efficiency of Use	The ways in which water is used for different purposes, including domestic, agriculture and industrial use. Scores to represent economic efficiency of use.
Environmental Impact	Designed to capture an evaluation of ecological integrity, related to water management decisions.
Geospatial conditions	Includes a number of geographical factors which relate specifically to the place or exposure to be examined.

**The Natural Baseline Endowment**

This provides a location classification according to natural hydrological regimes. In order to assess the WVM in practice, a rigorous hydrological assessment is required to reveal the baseline conditions which provide a constraint on water management choices.

**Geospatial variables**

The geospatial component is used to include the specific characteristics of the geographical type being examined in the WVM. Some examples of geospatial variables that might be defined are:

- Small islands – *Population in the zone at risk from sea level rise and isolation*, measured as a combination of distance from the nearest mainland and the land area of the island itself.
- Mountains – *Slope and temperature*.
- Urban areas in developing countries – *Population density and dependence on imported food*.

**The proposed structure of a Water Vulnerability Matrix**

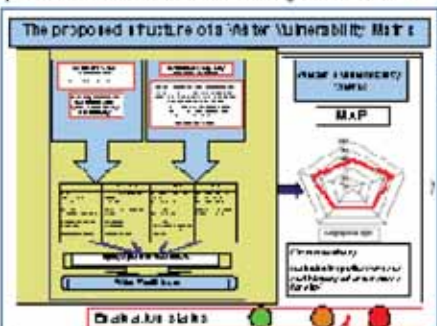



58



